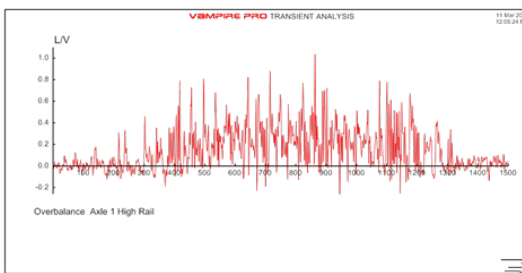
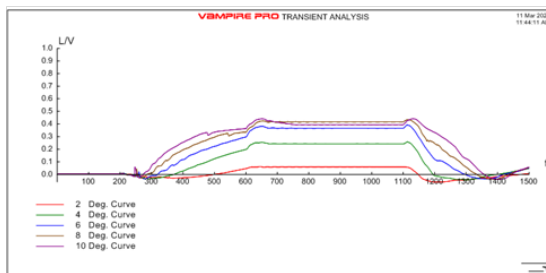
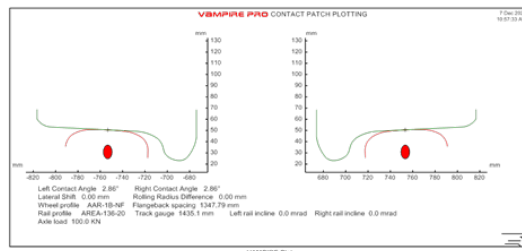
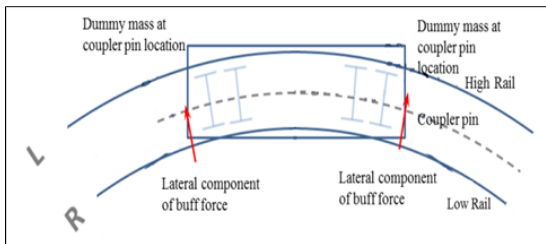
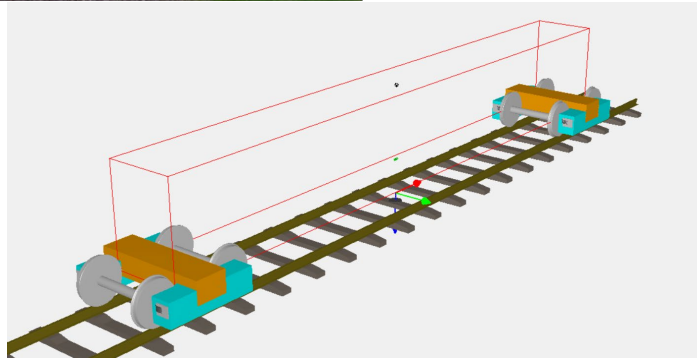




# Vehicle Dynamics Models for Derailment Incident Investigation



NOTICE

This document is disseminated under the sponsorship of the Department of Transportation in the interest of information exchange. The United States Government assumes no liability for its contents or use thereof. Any opinions, findings and conclusions, or recommendations expressed in this material do not necessarily reflect the views or policies of the United States Government, nor does mention of trade names, commercial products, or organizations imply endorsement by the United States Government. The United States Government assumes no liability for the content or use of the material contained in this document.

NOTICE

The United States Government does not endorse products or manufacturers. Trade or manufacturers' names appear herein solely because they are considered essential to the objective of this report.

## REPORT DOCUMENTATION PAGE

*Form Approved*  
OMB No. 0704-0188

The public reporting burden for this collection of information is estimated to average 1 hour per response, including the time for reviewing instructions, searching existing data sources, gathering and maintaining the data needed, and completing and reviewing the collection of information. Send comments regarding this burden estimate or any other aspect of this collection of information, including suggestions for reducing the burden, to Department of Defense, Washington Headquarters Services, Directorate for Information Operations and Reports (0704-0188), 1215 Jefferson Davis Highway, Suite 1204, Arlington, VA 22202-4302. Respondents should be aware that notwithstanding any other provision of law, no person shall be subject to any penalty for failing to comply with a collection of information if it does not display a currently valid OMB control number.

**PLEASE DO NOT RETURN YOUR FORM TO THE ABOVE ADDRESS.**

<b>REPORT DATE (DD-MM-YYYY)</b> 9/15/23	<b>2. REPORT TYPE</b> Technical Report	<b>3. DATES COVERED (From - To)</b> September 15, 2018–March 31, 2021
--	---	--

<b>4. TITLE AND SUBTITLE</b> Vehicle Dynamics Models for Incident Investigation	<b>5a. CONTRACT NUMBER</b> 693JJ618D000006
	<b>5b. GRANT NUMBER</b>
	<b>5c. PROGRAM ELEMENT NUMBER</b>

<b>6. AUTHOR(S)</b> Srini Swamy <a href="#">0000-0002-2266-5842</a> DeLong Fu <a href="#">0000-0001-7665-4738</a> Som P. Singh <a href="#">0000-0002-6076-6839</a>	<b>5d. PROJECT NUMBER</b>
	<b>5e. TASK NUMBER</b> 693JJ618F000116
	<b>5f. WORK UNIT NUMBER</b>

<b>7. PERFORMING ORGANIZATION NAME(S) AND ADDRESS(ES)</b> Sharma & Associates, Inc. 5810 S Grant Street Hinsdale, IL 60521	<b>8. PERFORMING ORGANIZATION REPORT NUMBER</b>
---	---

<b>9. SPONSORING/MONITORING AGENCY NAME(S) AND ADDRESS(ES)</b> U.S. Department of Transportation Federal Railroad Administration Office of Railroad Policy and Development Office of Research, Data, and Innovation Washington, DC 20590	<b>10. SPONSOR/MONITOR'S ACRONYM(S)</b>
	<b>11. SPONSOR/MONITOR'S REPORT NUMBER(S)</b> DOT/FRA/ORD-23/27

**12. DISTRIBUTION/AVAILABILITY STATEMENT**  
This document is available to the public through the FRA [website](#).

**13. SUPPLEMENTARY NOTES**  
COR: Tarek Omar

**14. ABSTRACT**  
When investigating a train derailment, vehicle/track interaction (VTI) using vehicle dynamics simulations of the key vehicles in the derailed train can help identify specific derailment causes. From September 2018 to March 2021, the Federal Railroad Administration (FRA) contracted Sharma & Associates, Inc. to develop a set of railway freight car models for the most prevalent car types in service using VAMPIRE®, a vehicle dynamics simulation software used in the railroad industry. The car types modeled in this research include hopper, covered hopper, lain box, equipped box (including refrigerated), tank, flat, double-stack, gondola and bi-level and tri-level Autorack. The team also created a library of wheel and rail profiles as well as track layout models for a range of curvatures. The results of the vehicle dynamics analyses of several freight car types illustrate the effectiveness of the modeling techniques in predicting key parameters of VTI. The team found that the vehicle dynamics models made from the library of cars, wheel, and rail profile combinations can be used in future derailment investigations when VTI is considered a possible cause. Based on measured track geometry data collected during an incident investigation, researchers can include track defects data to simulate a specific derailment.

**15. SUBJECT TERMS**  
Derailment, freight car dynamics, vehicle dynamics, VAMPIRE simulations, vehicle track interaction, wheel rail interaction

<b>16. SECURITY CLASSIFICATION OF:</b>			<b>17. LIMITATION OF ABSTRACT</b>	<b>18. NUMBER OF PAGES</b> 58	<b>19a. NAME OF RESPONSIBLE PERSON</b>
<b>a. REPORT</b>	<b>b. ABSTRACT</b>	<b>c. THIS PAGE</b>			<b>19b. TELEPHONE NUMBER (Include area code)</b>

## METRIC/ENGLISH CONVERSION FACTORS

### ENGLISH TO METRIC

#### LENGTH (APPROXIMATE)

- 1 inch (in) = 2.5 centimeters (cm)
- 1 foot (ft) = 30 centimeters (cm)
- 1 yard (yd) = 0.9 meter (m)
- 1 mile (mi) = 1.6 kilometers (km)

#### AREA (APPROXIMATE)

- 1 square inch (sq in, in<sup>2</sup>) = 6.5 square centimeters (cm<sup>2</sup>)
- 1 square foot (sq ft, ft<sup>2</sup>) = 0.09 square meter (m<sup>2</sup>)
- 1 square yard (sq yd, yd<sup>2</sup>) = 0.8 square meter (m<sup>2</sup>)
- 1 square mile (sq mi, mi<sup>2</sup>) = 2.6 square kilometers (km<sup>2</sup>)
- 1 acre = 0.4 hectare (he) = 4,000 square meters (m<sup>2</sup>)

#### MASS - WEIGHT (APPROXIMATE)

- 1 ounce (oz) = 28 grams (gm)
- 1 pound (lb) = 0.45 kilogram (kg)
- 1 short ton = 2,000 pounds (lb) = 0.9 tonne (t)

#### VOLUME (APPROXIMATE)

- 1 teaspoon (tsp) = 5 milliliters (ml)
- 1 tablespoon (tbsp) = 15 milliliters (ml)
- 1 fluid ounce (fl oz) = 30 milliliters (ml)
- 1 cup (c) = 0.24 liter (l)
- 1 pint (pt) = 0.47 liter (l)
- 1 quart (qt) = 0.96 liter (l)
- 1 gallon (gal) = 3.8 liters (l)
- 1 cubic foot (cu ft, ft<sup>3</sup>) = 0.03 cubic meter (m<sup>3</sup>)
- 1 cubic yard (cu yd, yd<sup>3</sup>) = 0.76 cubic meter (m<sup>3</sup>)

#### TEMPERATURE (EXACT)

$$[(x-32)(5/9)] \text{ } ^\circ\text{F} = y \text{ } ^\circ\text{C}$$

### METRIC TO ENGLISH

#### LENGTH (APPROXIMATE)

- 1 millimeter (mm) = 0.04 inch (in)
- 1 centimeter (cm) = 0.4 inch (in)
- 1 meter (m) = 3.3 feet (ft)
- 1 meter (m) = 1.1 yards (yd)
- 1 kilometer (km) = 0.6 mile (mi)

#### AREA (APPROXIMATE)

- 1 square centimeter (cm<sup>2</sup>) = 0.16 square inch (sq in, in<sup>2</sup>)
- 1 square meter (m<sup>2</sup>) = 1.2 square yards (sq yd, yd<sup>2</sup>)
- 1 square kilometer (km<sup>2</sup>) = 0.4 square mile (sq mi, mi<sup>2</sup>)
- 10,000 square meters (m<sup>2</sup>) = 1 hectare (ha) = 2.5 acres

#### MASS - WEIGHT (APPROXIMATE)

- 1 gram (gm) = 0.036 ounce (oz)
- 1 kilogram (kg) = 2.2 pounds (lb)
- 1 tonne (t) = 1,000 kilograms (kg)
- = 1.1 short tons

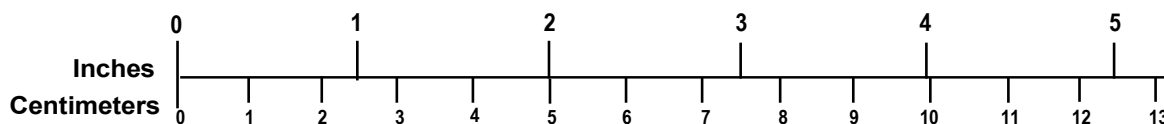
#### VOLUME (APPROXIMATE)

- 1 milliliter (ml) = 0.03 fluid ounce (fl oz)
- 1 liter (l) = 2.1 pints (pt)
- 1 liter (l) = 1.06 quarts (qt)
- 1 liter (l) = 0.26 gallon (gal)
- 1 cubic meter (m<sup>3</sup>) = 36 cubic feet (cu ft, ft<sup>3</sup>)
- 1 cubic meter (m<sup>3</sup>) = 1.3 cubic yards (cu yd, yd<sup>3</sup>)

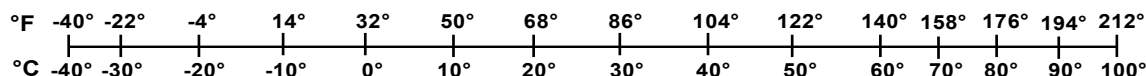
#### TEMPERATURE (EXACT)

$$[(9/5) y + 32] \text{ } ^\circ\text{C} = x \text{ } ^\circ\text{F}$$

### QUICK INCH - CENTIMETER LENGTH CONVERSION



### QUICK FAHRENHEIT - CELSIUS TEMPERATURE CONVERSION



For more exact and or other conversion factors, see NIST Miscellaneous Publication 286, Units of Weights and Measures. Price \$2.50 SD Catalog No. C13 10286

Updated 6/17/98

# Contents

---

Executive Summary .....	9
1. Introduction .....	10
1.1 Background .....	10
1.2 Objectives .....	10
1.3 Overall Approach .....	10
1.4 Scope .....	12
1.5 Organization of the Report .....	12
2. Freight Car Models.....	13
2.1 Box Car.....	13
2.2 Equipped Box Car .....	14
2.3 Covered Hopper Car.....	15
2.3.1 Covered Hopper: 110-ton.....	15
2.3.2 Covered Hopper: 125-ton.....	16
2.4 Open Top Hopper Car .....	16
2.5 Gondola Car .....	17
2.6 Flat Car .....	18
2.7 Three-unit Double Stack Container Car.....	19
2.8 Five-unit Double Stack Container Car .....	20
2.9 Tank Car .....	21
2.10 Autorack Car .....	21
2.10.1 Bi-level Autorack Car .....	22
2.10.2 Tri-level Autorack Car .....	23
3. Track Geometry.....	25
3.1 Constant Curve Design.....	25
3.2 Track Irregularities .....	25
3.3 Typical FRA Class 3 and Class 4 Track Geometry Defects .....	26
3.3.1 Class 3 Vertical Irregularity .....	26
3.3.2 Class 3 Lateral Irregularity.....	27
3.3.3 Class 4 Irregularity .....	27
4. Wheel and Rail Profiles.....	28
4.1 Wheel.....	28
4.1.1 AAR-1B Wheel Profile .....	28
4.1.2 AAR-2A Wheel Profile .....	29
4.1.3 Worn Wheel .....	29
4.2 Rail .....	29
4.2.1 AREMA 132.....	30
4.2.2 AREMA 136.....	30

4.3	Summary .....	30
5.	Vehicle Dynamics Simulation Results .....	31
5.1	Criteria for Assessment .....	31
5.1.1	Wheel L/V Ratio .....	32
5.1.2	Truck Side L/V .....	32
5.1.3	Minimum Vertical Load (% Wheel Unloading).....	32
5.2	Covered Hopper Car.....	32
5.2.1	Steady State Curve (No Perturbations) .....	32
5.2.2	Curving with Track Perturbations .....	35
5.3	Three-Unit Double Stack Container Car .....	38
5.3.1	Steady State Curve (No Perturbations) .....	38
5.3.2	Response for Track with Perturbations .....	40
5.4	Tank Car .....	43
5.4.1	Steady State Curve (No Perturbations) .....	43
5.4.2	Response for Track with Perturbations .....	47
5.5	Bi-Level Autorack Car .....	48
5.5.1	Steady State Curve (No Track Perturbations) .....	48
5.5.2	Response for Track with Perturbations .....	51
6.	Summary and Conclusions .....	54
	References .....	55
	Abbreviations and Acronyms .....	56

## Illustrations

---

Figure 1. VAMPIRE Railcar Model .....	11
Figure 2. Box Car Main Dimensions .....	14
Figure 3. Typical Refrigerator Car.....	14
Figure 4. Refrigerator Car Main Dimensions .....	15
Figure 5. The 110-Ton Covered Hopper Car.....	15
Figure 6. Hopper Car Main Dimensions.....	16
Figure 7. Open Top Hopper Car .....	17
Figure 8. Gondola Car.....	17
Figure 9. Flat Car .....	18
Figure 10. Three-Unit Double Stack Container Car .....	19
Figure 11. VAMPIRE Model of Three-Unit Container Car .....	20
Figure 12. Five-Unit Double Stack Container Car .....	20
Figure 13. Tank Car .....	21
Figure 14 Swing Motion Truck – Exploded View (Courtesy: Amsted Rail) .....	22
Figure 15. Bi-level Autorack Car.....	23
Figure 16. VAMPIRE Model of a Bi-level Autorack Car .....	23
Figure 17. Tri-level Autorack Car .....	24
Figure 18. VAMPIRE Plots for Curvature and Superelevation for a 4-Degree Curve.....	25
Figure 19. Class 3 Track Irregularities .....	26
Figure 20. Class 4 Track Irregularities .....	27
Figure 21 AAR-1B Narrow Flange Wheel Profile on AREMA 136-20 Rail Profile.....	28
Figure 22. AAR-2A Wheel Profile on AREMA 136-20 Rail Profile.....	29
Figure 23. Hollow Worn Wheel Profile on AREMA 136-20 Rail Profile .....	29
Figure 24. Wheel L/V Ratio for Loaded Covered Hopper Car on a 6-Degree Curve .....	32
Figure 25. Wheel L/V Ratios Over a Range of Curves at Balance Speeds (Loaded Covered Hopper Car) .....	33
Figure 26. Wheel L/V Ratio for Empty Covered Hopper Car .....	33
Figure 27. Wheel L/V Ratios Over a Range of Curvatures at Balance Speeds (Empty Covered Hopper Car) .....	34
Figure 28. Truck Side L/V Ratio for Loaded Covered Hopper Car .....	34
Figure 29. Truck Side L/V Ratio for Empty Covered Hopper Car.....	34
Figure 30. Wheel L/V Ratio, Loaded Covered Hopper (6-Degree Curve with Perturbation).....	35

Figure 31. Wheel L/V Ratio, Empty Covered Hopper Car (6-Degree Curve with Perturbation)	36
Figure 32. Exceedance of Maximum Wheel L/V Ratio – Distance Plot .....	36
Figure 33 Exceedance of Maximum Wheel L/V Ratio – Time Plot.....	36
Figure 34. Truck Side L/V Ratio, Empty Covered Hopper Car (6-Degree Curve with Perturbation) .....	37
Figure 35. Exceedance of Maximum Truck Side L/V Ratio (6-Degree Curve with Perturbation) .....	37
Figure 36. Wheel L/V Ratio for Loaded Three-Unit Container Car (6-Degree Curve) .....	38
Figure 37. Wheel L/V Ratio Over a Range of Curves (Loaded Three-Unit Container Car) .....	38
Figure 38. Wheel L/V Ratio for an Empty, Three-Unit Container Car (6-Degree Curve).....	39
Figure 39. Wheel L/V Ratios Over a Range of Curvatures (Empty Three-Unit Car) .....	39
Figure 40. Truck Side L/V Ratio for the Loaded Three-Unit Container Car (6-Degree Curve) ..	40
Figure 41. Truck Side L/V Ratio for the Empty Three-Unit Container Car (6-Degree Curve) ...	40
Figure 42. Wheel L/V Ratio, Loaded Three-Unit Container Car .....	41
Figure 43. Wheel L/V Ratio, Empty Three-Unit Container Car.....	41
Figure 44. Wheel L/V Ratio, Empty Three-Unit Container Car.....	42
Figure 45 Truck Side L/V Ratio, Empty Three-Unit Container Car .....	42
Figure 46. Wheel L/V Ratio for a Loaded Tank Car (Steady State Curve).....	43
Figure 47. Wheel L/V Ratios Over a Range of Curves (Loaded Tank Car).....	43
Figure 48. Wheel L/V Ratio for an Empty Tank Car .....	44
Figure 49. Wheel L/V Ratios Over a Range of Curvatures (Empty Tank Car).....	44
Figure 50. Truck Side L/V Ratio for Loaded Tank Car.....	44
Figure 51. Truck Side L/V Ratio for an Empty Tank Car .....	45
Figure 52. Car Model with Lateral Component of Coupler Forces .....	45
Figure 53. Wheel L/V Ratio, Empty Tank Car, 6-Degree Curve (Buff) .....	46
Figure 54. Wheel L/V Ratio, Empty Tank Car, 6-Degree Curve (Draft) .....	46
Figure 55. Wheel L/V Ratio, Loaded Tank Car (6-Degree Curve with Perturbations).....	47
Figure 56. Wheel L/V Ratio, Empty Tank Car (6-Degree Curve with Perturbations) .....	48
Figure 57. Wheel L/V Ratio for a Loaded Autorack Car (Steady State Curve) .....	49
Figure 58. Wheel L/V Ratios Over a Range of Curves (Loaded Autorack Car) .....	49
Figure 59. Wheel L/V Ratio for an Empty Autorack Car (Steady State Curve) .....	49
Figure 60. Wheel L/V Ratios Over a Range of Curves (Empty Autorack Car) .....	50
Figure 61. Truck Side L/V Ratio for a Loaded Autorack Car (Steady State Curve).....	50



Figure 62. Truck Side L/V Ratio for an Empty Autorack Car (Steady State Curve) .....	51
Figure 63. Wheel L/V Ratio, Loaded Autorack Car (6-Degree Curve with Perturbations) .....	52
Figure 64. Wheel L/V Ratio, Empty Autorack Car (6-Degree Curve with Perturbations) .....	52
Figure 65. Wheel L/V Ratio, Zoomed-in, Distance Scale .....	52
Figure 66. Wheel L/V Ratio, Zoomed-in Time Scale.....	53

## Tables

---

Table 1. 2020 Freight Car Data for North American Railroads .....	11
Table 2 Truck Types .....	13
Table 3. Box Car Specifications .....	14
Table 4. Refrigerator Car Specifications .....	15
Table 5. The 110-ton Covered Hopper Car Specifications.....	16
Table 6. The 125-ton Covered Hopper Car Specifications.....	16
Table 7. Open Top Hopper Car Specifications.....	17
Table 8. Gondola Car Specifications .....	18
Table 9. Flat Car Specifications.....	18
Table 10. Three-Unit Container Car Specifications .....	19
Table 11. Five-Unit Container Car Specifications.....	20
Table 12. Tank Car Specifications.....	21
Table 13. Bi-level Autorack Car Specifications .....	23
Table 14. Tri-level Autorack Car Specifications .....	24
Table 15. Curves for VAMPIRE .....	25
Table 16. Simulation Matrix .....	31
Table 17. Predicted Covered Hopper Car Response (Maximum Values from the Three Speeds, Steady State Curve).....	35
Table 18. Predicted Covered Hopper Car Response (Track with Perturbations) .....	37
Table 19. Predicted Three-Unit Container Car Response (Steady State Curve) .....	40
Table 20. Predicted Three-Unit Container Car Response (Track with Perturbations) .....	42
Table 21. Predicted Tank Car Response (Steady State Curve).....	45
Table 22. Predicted Tank Car Response on a 6-Degree Steady State Curve.....	47
Table 23. Predicted Tank Car Response .....	48
Table 24. Predicted Autorack Car Response (Steady State Curve) .....	51
Table 25. Predicted Autorack Car Response .....	53

## Executive Summary

---

When investigating a train derailment, studying the vehicle/track interaction (VTI) using vehicle dynamics simulations of the key vehicles in the derailed train can help identify specific derailment causes. From September 2018 to March 2021, the Federal Railroad Administration (FRA) contracted Sharma & Associates, Inc. to develop a set of railway freight car models for the most prevalent car types in service using VAMPIRE®, a vehicle dynamics simulation software employed by the railroad industry. The car types modeled in this research include hopper, covered hopper, lain box, equipped box (including refrigerated), tank, flat, double-stack, gondola and bi-level and tri-level Autorack. The team also created a library of wheel and rail profiles as well as track layout models for a range of curvatures.

This report describes generic models of these car types that can be readily modified into specific configurations required for accurate simulations. In this research, the team carried out simulations for a varying degree of curvature track with no track geometry defects. The team then developed track models with geometry defects typical of FRA Class 3 and Class 4 tracks to demonstrate how the dynamic response of a vehicle may differ from a designed-track layout due to local track geometry defects.

This report examines how the effect of in-train coupler forces derived from the Train Energy and Dynamics Simulator (TEDS) of a derailment scenario can be modeled in the vehicle dynamics simulation of a particular train car during an investigation. FRA frequently employs simulations of train derailments using TEDS to better understand train dynamics and investigate probable derailment causal factors. While TEDS simulations can identify train action and train handling effects, the results of these simulations often are not sufficient to completely identify the derailment mechanisms at the wheel/rail interface level (e.g., wheel-climb or rail rollover). To make a timely determination of derailment causal factors, it is important to understand the fundamental wheel/rail interaction mechanisms resulting from vehicle dynamics. Derailment causes can be more quickly and specifically identified when investigators use TEDS to examine individual vehicle dynamics simulations of the key vehicles involved.

The results of the vehicle dynamics analyses of several freight car types illustrate the effectiveness of the modeling techniques in predicting key parameters of VTI. The team found that the vehicle dynamics models made from the library of car, wheel, and rail profile combinations can be used in future derailment investigations when VTI is considered a possible cause. Using the models, researchers will be able to input measured track defect data from a derailment incident investigation to simulate and study the specific derailment. This can be a valuable tool in derailment investigation.

# 1. Introduction

---

The Federal Railroad Administration's (FRA) Office of Research, Development, and Technology plays an important role in supporting FRA's Office of Safety in the enactment and enforcement of railroad regulations and investigations of derailment incidents. These incidents can be related to defective equipment, poor track conditions, improper train makeup or handling, and the resultant train and vehicle dynamics.

When investigating a train derailment, vehicle/track interaction (VTI) using vehicle dynamics simulations of the key vehicles in the derailed train can help identify specific derailment causes. From September 2018 to March 2021, FRA contracted Sharma & Associates, Inc. to develop a set of railway freight car models for the most prevalent car types in service using VAMPIRE®, an interactive platform that enables modeling and computer simulations of multi-body dynamic systems that is commonly used in the rail industry. The car types modeled in this research include hopper, covered hopper, lain box, equipped box (including refrigerated), tank, flat, double-stack, gondola and bi-level and tri-level Autorack. The team also created a library of wheel and rail profiles as well as track layout models for a range of curvatures.

## 1.1 Background

FRA frequently conducts simulations of train derailments using the Train Energy and Dynamics Simulator (TEDS) to better understand train dynamics and investigate probable causal factors from train and track interactions that may have contributed to an incident. While TEDS simulations can identify train action and train handling effects, the results of these simulations often are not sufficient to completely identify the derailment mechanism at the wheel/rail interface level if wheel-climb or rail rollover is also a factor.

For a timely resolution of the derailment causal factors, it is important to understand the results of these fundamental wheel/rail interaction mechanisms. Derailment causes can be more quickly and specifically identified when TEDS simulations include individual vehicle dynamics simulations of the key vehicles in the train. A comprehensive set of simulation models based on representative vehicles and wheel/rail profiles would be beneficial during derailment investigations.

## 1.2 Objectives

The objective of this project was to prepare a library of freight car models and representative track to guide derailment investigations, especially those in which individual vehicle dynamics and wheel/rail forces may have played a key role in the derailment. The creation of a library of models and input files reduces the model setup time and expedites running simulations after derailments.

## 1.3 Overall Approach

The research team created a library of railway freight car models for 12 different car types in the railway vehicle dynamics software platform VAMPIRE.

Researchers identified a set of representative railroad cars for modeling in VAMPIRE based on the actual distribution of the vehicle types in Class I railroads in North America ([Table 1](#)). The

data is based on Railroad Fact 2020, published by the Association of American Railroads (AAR). The car models included both empty and loaded conditions for the freight cars listed in the table.

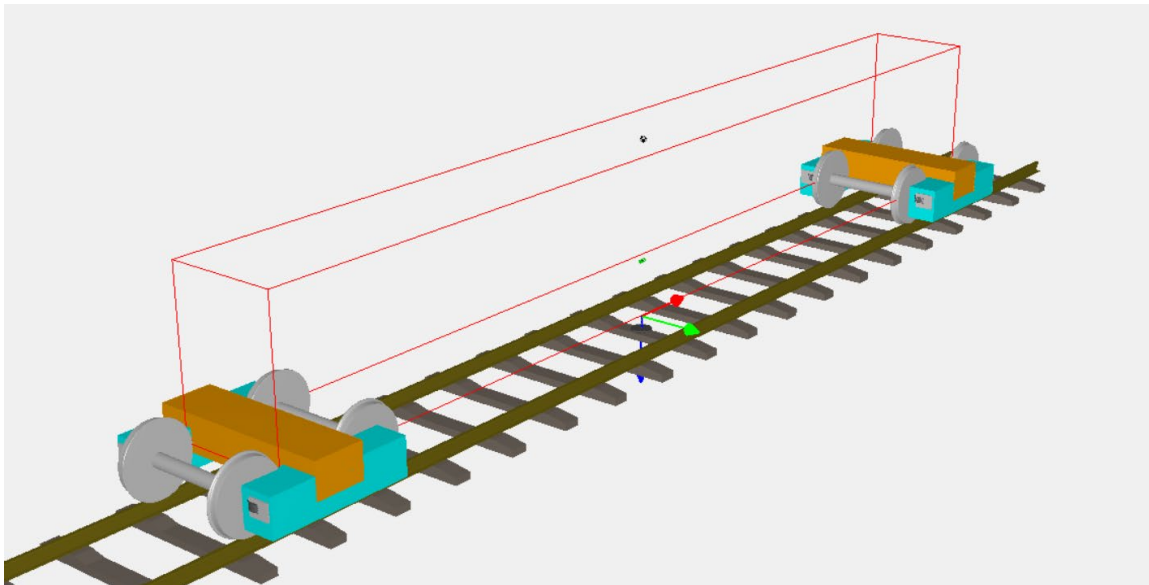
The team also created a library of track models for a range of curvatures. To demonstrate the effects of measured track geometry on the dynamic response of the freight cars, the team developed track models with track/defect perturbations typical of FRA Class 3 and Class 4 tracks. Railroads can provide this data for the track segment involved in a derailment incident when vehicle dynamics simulations are required to investigate the VTI contribution.

In this report, the results of vehicle dynamics analyses of a sub-set of 12 freight car types illustrated the effectiveness of the modeling techniques in predicting key parameters of the VTI. Bi-level Autorack cars discussed in [Section 2](#) were included in the “other” category in [Table 1](#).

**Table 1. 2020 Freight Car Data for North American Railroads**

Car Type	Number	% of total cars
Covered Hopper	572,600	34.2%
Tank Car	432,600	25.8%
Flat Cars	212,300	12.7%
Gondola	205,800	12.3%
Hoppers	131,200	7.8%
Equipped Box, incl. Refrigerator Cars	100,700	6.0%
Plain Box	16,100	1.0%
Others, include Autorack Cars	4,300	0.2%

The VAMPIRE freight car model library included four additional car models: the 125-ton covered hopper car in the Covered Hopper category, the three-unit and five-unit double stack container cars in the Flat Car category, and tri-level Autorack cars in the Other category. [Figure 1](#) shows the multi-body vehicle dynamics model of a railcar as represented in VAMPIRE.



**Figure 1. VAMPIRE Railcar Model**

The team created representative sections of curved track models for a range of curvatures from 2 degrees to 10 degrees in 2-degree increments. The curved track library in VAMPIRE includes cases with and without track perturbations or irregularities, also known as track geometry defects. The track perturbations included are typical of FRA Class 3 and Class 4 tracks.

The team conducted simulations to evaluate dynamic responses of the various car types for a range of operating speeds. The computer simulations included other parameters such as wheel and rail profiles, longitudinal coupler forces due to train braking or traction, and rail and center plate lubrication conditions.

#### **1.4 Scope**

This research effort included identifying a set of representative freight cars for vehicle dynamics modeling and defining the curving simulation cases for a subset of these models. The scope also included identifying representative wheel and rail profiles and track geometry defects for use in the simulations. The results of these simulations are discussed in view of the existing industry standards for vehicle safety performance criteria under steady-state and transient responses.

#### **1.5 Organization of the Report**

This report details the development of a library of freight car and railroad track models using VAMPIRE.

[Section 2](#) describes the freight car models developed for this project. [Section 3](#) details the VAMPIRE track files created. [Section 4](#) includes the wheel and rail profiles models. [Section 5](#) describes the simulation cases and the results of the dynamic simulations of the selected vehicle. Finally, [Section 6](#) summarizes the report and research conclusions.

## 2. Freight Car Models

---

This section describes the characteristics of freight cars included in the library of VAMPIRE vehicle models. The team obtained relevant specifications for these cars, including the main dimensions and weights, from the Car and Locomotive Cyclopaedia of American Practices (Kratville, 1997). The photographs used in this report were taken from the U.S. International Trade Commission Report (Andersen, 2011).

The truck modelled for this study was a generic three-piece North American freight car truck with friction wedges and variable damping (except where noted in the report). [Table 2](#) lists the types of cars with the corresponding types of trucks modelled to create the library. For a 110-ton freight car, the axle load is 71,500 lb. The car was equipped with two standard three-piece trucks with 36-inch diameter wheels and Class K (6.5" x 11") journal bearings.

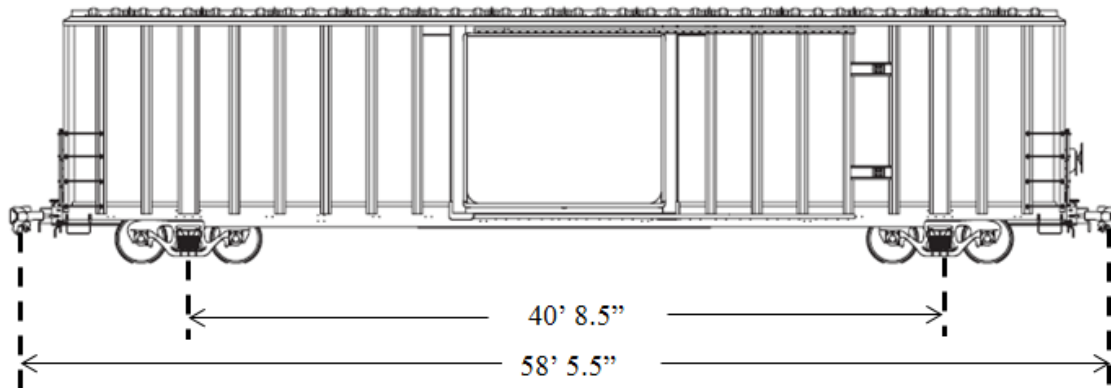
**Table 2 Truck Types**

Car Type	Truck Type
Box, Equipped Box, 110-ton Covered Hopper, Open Top Hopper, Flat, Gondola, Tank	100-ton Three-Piece Trucks
125-ton Covered hopper Car	125-ton Three-Piece Trucks
3-Unit Double Stack Container Car	Two 70-ton Three-Piece Trucks and Two 125-ton Trucks with Articulated Connectors
5-Unit Double Stack Container Car	Two 70-ton Three-Piece Trucks and Four 125-ton Trucks with Articulated Connectors
Bi-level Autorack Car	70-ton Swing Motion Trucks with 33" diameter wheels
Tri-level Autorack Car	70-ton Swing Motion Trucks with 28" diameter wheels

The model of the 110-ton freight car included two trucks consisting of the standard AAR spring group with seven D5 outers, seven D5 inners, two D6A second inners, and a variable damped friction wedge damping system as specified in the AAR Manual of Standards and Practices (MSRP) Section D. The car and truck interface also included two constant contact side bearings with a preload of 6,000 lb, one on each side of the truck center bowl.

### 2.1 Box Car

Box cars carry paper, food products, and other common commodities. Between 1984 and 2008, the number of plain box cars in North American railroads decreased significantly from 160,000 to around 16,200, falling from 10.8 percent to approximately 1 percent of the total fleet. Most of the commodities carried in this type of car are now transported more efficiently in intermodal service. [Figure 2](#) shows a diagram of a typical high cube box car with main dimensions. [Table 3](#) shows the car specifications used in the model.



**Figure 2. Box Car Main Dimensions**

**Table 3. Box Car Specifications**

Length over coupler pulling faces	58'-5.5"
Length over strikers	53'-9.5"
Distance between truck centers	40'-8.5"
Width, extreme	10'-8"
Height, extreme	16'-10"
Gross Rail Load	286,000 lb
Light Weight (tare)	75,000 lb
Cubic capacity	6,197 cu ft

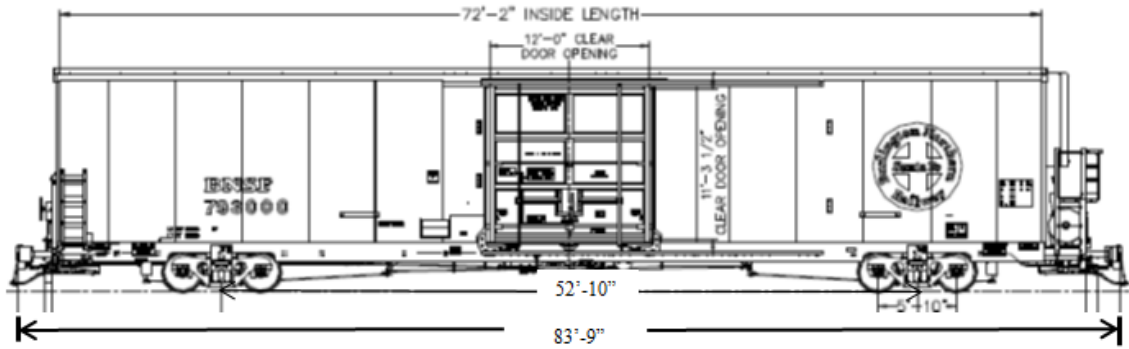
## 2.2 Equipped Box Car

The team chose a Refrigerator Car as the type of equipped box car in the VAMPIRE vehicle model library. Refrigerated rail cars protect perishable food products using both cold and heated storage. [Figure 3](#) shows a typical refrigerator car. The mechanical refrigeration/heating unit is housed behind the grill at the lower right, at the car's "A" end as shown in the figure. [Figure 4](#) notes the main dimensions of the car. [Table 4](#) lists the car specifications.



**Figure 3. Typical Refrigerator Car**





**Figure 4. Refrigerator Car Main Dimensions**

**Table 4. Refrigerator Car Specifications**

Length over coupler pulling faces	83'-9"
Length over strikers	78'-7"
Distance between truck centers	52'-10"
Width, extreme	10'-3 <sup>5</sup> / <sub>8</sub> "
Height, extreme	17'
Gross Rail Load	286,000 lb
Light Weight (tare)	102,300 lb
Cubic capacity	7,926 cu ft

## 2.3 Covered Hopper Car

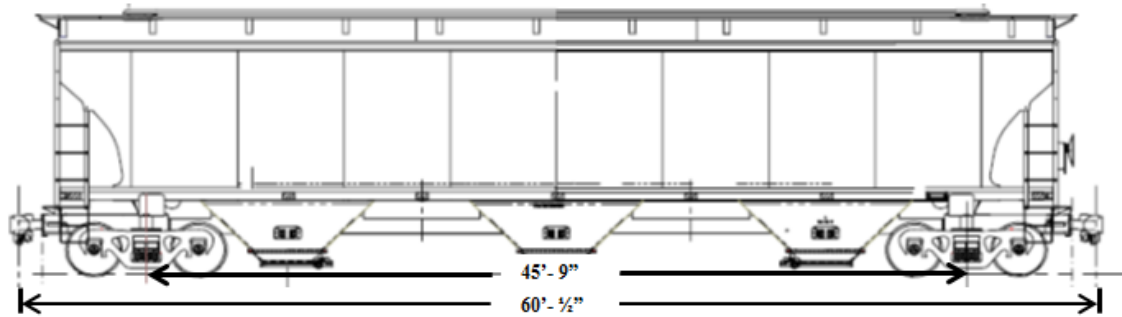
The following details the covered hopper cars used in this research.

### 2.3.1 Covered Hopper: 110-ton

Covered hopper cars are the most common freight car type in North American railroads, comprising 34 percent of the fleet (see [Table 1](#)). [Figure 5](#) shows a 110-ton covered hopper car and [Figure 6](#) provides a schematic. [Table 5](#) lists the car specifications.



**Figure 5. The 110-ton Covered Hopper Car**



**Figure 6. Hopper Car Main Dimensions**

**Table 5. The 110-ton Covered Hopper Car Specifications**

Length over coupler pulling faces	60'- 0.5"
Length over strikers	57'-5"
Distance between truck centers	45'-9"
Width, extreme	10'-7 $\frac{1}{8}$ "
Height, extreme	15'-6"
Gross Rail Load	286,000 lb
Light Weight (tare)	62,200 lb
Cubic capacity	5,161 cu ft

### 2.3.2 Covered Hopper: 125-ton

The 125-ton covered hopper car has a heavier axle load compared to the 110-ton covered hopper. The modelled car has two three-piece trucks with 38" diameter wheels and Class G (7" x 12") journal bearings. The trucks are equipped with S2-HD spring groups with seven D5 outers, seven D6 inners, and five D6A second inners. The variable damped system also includes one outer B-353 and inner B-354 side spring below each split friction wedge, as shown in [Table 6](#).

**Table 6. The 125-ton Covered Hopper Car Specifications**

Length over coupler pulling faces	60'- 0.5"
Length over strikers	57'-5"
Distance between truck centers	45'-9"
Width, extreme	10'-7 $\frac{1}{8}$ "
Height, extreme	15'-6"
Gross Rail Load	315,000 lb
Light Weight (tare)	62,200 lb
Cubic capacity	5,161 cu ft

## 2.4 Open Top Hopper Car

Open top hopper cars transport heavy bulk commodities including coal, cokes, metallic ores, scrap metal, sand, stone, and gravel, where exposure to weather elements is not a concern. [Figure 7](#) shows an example of a 110-ton open top hopper car and [Table 7](#) lists its specifications.



**Figure 7. Open Top Hopper Car**

**Table 7. Open Top Hopper Car Specifications**

Length over coupler pulling faces	53'-0.5"
Length over strikers	50'-5"
Distance between truck centers	40'-6"
Width, extreme	10'-8"
Height, extreme	13'-3 1/4"
Gross Rail Load	286,000 lb
Light Weight (tare)	50,500 lb
Cubic capacity	4,200 cu ft

## 2.5 Gondola Car

Gondola cars transport commodities like coal, ores, and wood chips. [Figure 8](#) shows an example of a mill gondola car. [Table 8](#) lists the specifications of the modelled car.



**Figure 8. Gondola Car**

**Table 8. Gondola Car Specifications**

Length over coupler pulling faces	70'-11.5"
Length over strikers	68'-4"
Distance between truck centers	55'-9"
Width, extreme	9'- 10.5"
Height, extreme	9'- $\frac{7}{16}$ "
Gross Rail Load	286,000 lb
Light Weight (tare)	72,000 lb
Cubic capacity	3,242 cu ft

**2.6 Flat Car**

The heavy duty flat car fleet consists of depressed center cars, flat deck cars with a capacity of 100 tons or greater, and well cars that include a well in the center so lading can be lowered for clearance limits. Principal commodities shipped on flat cars include intermodal containers and road trailers, lumber, pipes, plywood, drywall, and pulpwood. Figure 9 shows an example of a flat deck car, while Table 9 provides the car data. Table 9 lists the specifications of the modelled car.



**Figure 9. Flat Car**

**Table 9. Flat Car Specifications**

Length over coupler pulling faces	65'-4"
Length over strikers	60'-8"
Distance between truck centers	44'-6"
Width, extreme	10'- 8"
Deck height	3'-7"
Stroke length for end of car cushioning	15"
Gross Rail Load	286,000 lb
Light Weight (Tare)	72,800 lb

## 2.7 Three-unit Double Stack Container Car

Three-unit double stack container car are joined with articulated connectors. Each car is equipped with two 70-ton trucks at the ends and two 125-ton trucks with articulated connectors at the intermediate locations. The 70-ton truck has seven D5 outers and two each B-432 and B-433 wedge springs in each spring group, while the 125-ton trucks have the same spring groups previously mentioned in Section 2.3.2. Figure 10 shows an example of the three-unit container car. A full range of domestic and International Organization for Standardization containers can be shipped using these cars. The well accommodates one fully loaded 40 or 53 ft container or two 20 ft containers, while the upper stack typically accommodates one fully loaded 40 to 53 ft container or two 20 ft containers. Table 10 lists the three-unit container car data. The parameters in the table (e.g., Gross Rail Load) are consistent with Rakoczy (2019). Figure 11 shows the VAMPIRE model of the vehicle where the end platforms are connected to the middle platform using models of articulated connectors.

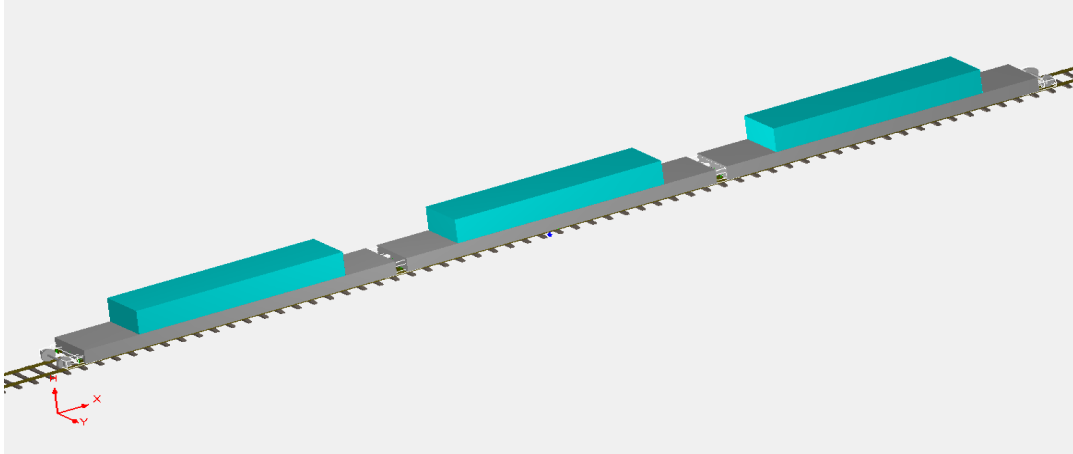


**Figure 10. Three-Unit Double Stack Container Car**

**Table 10. Three-Unit Container Car Specifications**

Length over coupler pulling faces	204'-8 $\frac{1}{16}$ "
Length over strikers	202'- $\frac{9}{16}$ "
Distance between centers of 70-ton and 125-ton trucks	63'- 6 $\frac{5}{8}$ "
Distance between centers of the two 125-ton trucks	63'- 11 $\frac{1}{4}$ "
Width, extreme (Plate "H-1")	10'- 8"
Height with two stacked containers, extreme (Plate "H-1")	20'-3"
Gross Rail Load	485,000 lb
Light Weight (tare)	125,500 lb





**Figure 11. VAMPIRE Model of Three-Unit Container Car**

## 2.8 Five-unit Double Stack Container Car

The design of this car is like the of the three-unit car with two additional articulated platforms. The car has two 70-ton trucks at the ends and four 125-ton trucks with articulated connectors at the intermediate locations (see Figure 12). Table 11 lists the car specifications.



**Figure 12. Five-Unit Double Stack Container Car**

**Table 11. Five-Unit Container Car Specifications**

Length over coupler pulling faces	266'-8 $\frac{3}{16}$ "
Length over strikers	264'-7 $\frac{7}{8}$ "
Distance between centers of 70-ton and 125-ton trucks	50'-7 $\frac{3}{8}$ "
Distance between centers of the two 125-ton trucks	50'-7 $\frac{3}{8}$ "
Width, extreme (Plate "H-1")	10'-8"
Height with two stacked containers, extreme (Plate "H-1")	20'-3"
Gross Rail Load	800,000 lb
Light Weight (tare)	181,860 lb

The well typically accommodates one 40 ft container in the bottom and one 40, 45, or 48 ft container at the top. The well can also carry two 20 ft containers in the bottom instead of a 40 ft container. These types of cars improve the efficiency of intermodal transportation and therefore, use of these cars has become prevalent with railroads shipping containers from ports to destinations across the country. The parameters in the table are consistent with Rakoczy, (2019).

## 2.9 Tank Car

Tank cars are the primary means of bulk liquid transportation. The cars are used to transport chemicals, petroleum products, and pressurized gases. Although tank cars are usually associated with the movement of hazardous materials, half of these shipments are non-regulated food and industrial products. Figure 13 shows a typical tank car. Table 12 lists the car specifications used in the VAMPIRE model. The car was modelled with two 100-ton, three-piece trucks. The spring group consisted of seven D5 outers and seven D5 inners, and a 5062 outer side spring and a 5063 inner side spring under each friction wedge.



Figure 13. Tank Car

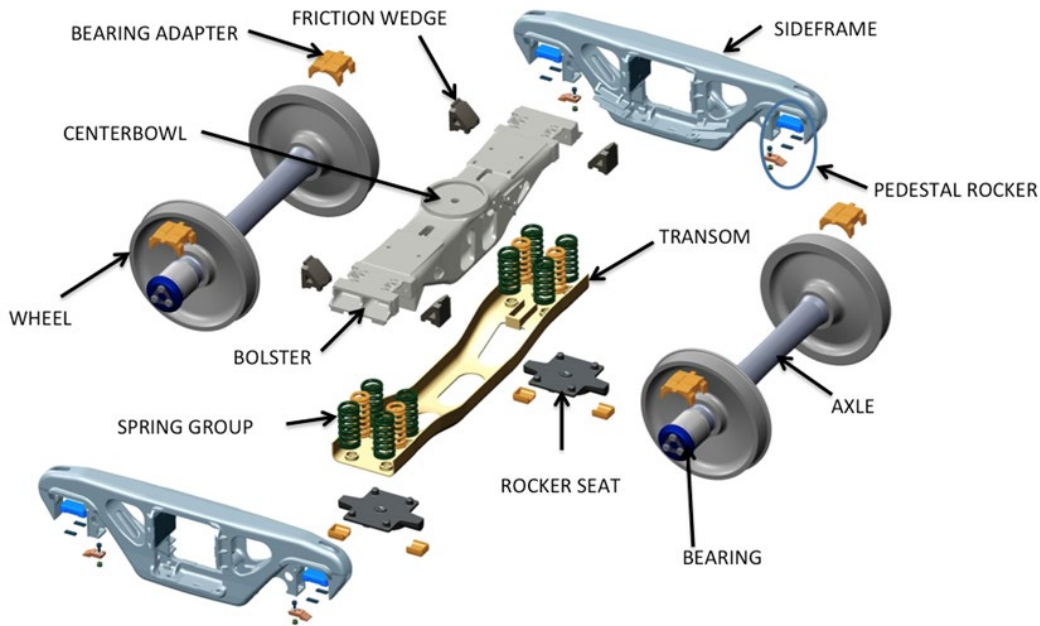
Table 12. Tank Car Specifications

Length over coupler pulling faces	61'-3 1/4"
Length over strikers	58'-7 1/4"
Distance between truck centers	47'-8 1/4"
Width, extreme	10'-7 1/4"
Height, extreme	15'-1/4"
Gross Rail Load	263,000 lb
Light Weight (tare)	76,800 lb

## 2.10 Autorack Car

Over the years, the design of Autorack cars has evolved to provide damage-free transportation of automobiles. In addition to bi-level and tri-level Autorack cars, there is also a car with adjustable deck height that allows for bi-level or tri-level configurations.

The Autorack car is equipped with two 70-ton Swing Motion trucks. [Figure 14](#) shows an exploded view of a Swing Motion truck (Schorr, 2015). The main springs are comprised of five D5 outers and three D5 inners in each spring group. The Swing Motion truck has additional elements including a transom that connects the two side frames at the bottom (in addition to the bolster) and a specially designed interface between the side frames and bearing adapters. Rocker seats are provided between the side frame and transom as well as between the side frame pedestal and bearing adapters. These features allow more controlled movement and rotation about multiple axes, providing better stabilization of the dynamic loads.



**Figure 14 Swing Motion Truck – Exploded View (Courtesy: Amsted Rail)**

The Swing Motion trucks provide superior ride quality and improved lading protection in the Autorack cars when compared to conventional three-piece trucks. The performance improvement of the more advanced Swing Motion truck design is ideal for transportation of automobiles and other finished goods and allows for improved steering in curves and load transfer between the truck components. The VAMPIRE model of the Autorack car included the special features of the Swing Motion truck.

### **2.10.1 Bi-level Autorack Car**

This type of freight car accommodates two decks of vehicles, including pickup trucks, SUVs, and minivans. The Autorack car can accommodate up to eight vehicles. [Figure 15](#) shows a schematic of the bi-level Autorack car and [Table 13](#) lists the car specifications. [Figure 16](#) shows the VAMPIRE model of the car. The automobile mass, suspension and tire stiffness were modelled to account for displacements due to vertical bumps on the track and ensure the automobiles do not come off the chocks that secure the automobile wheels. The 70-ton Swing Motion trucks have 33-inch diameter wheels.

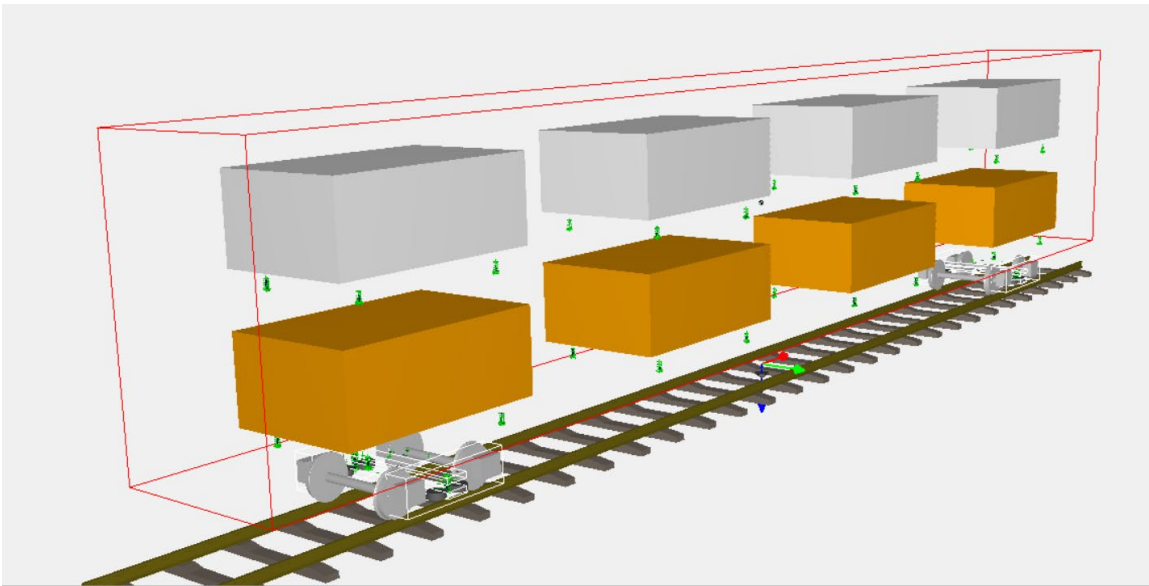




**Figure 15. Bi-level Autorack Car**

**Table 13. Bi-level Autorack Car Specifications**

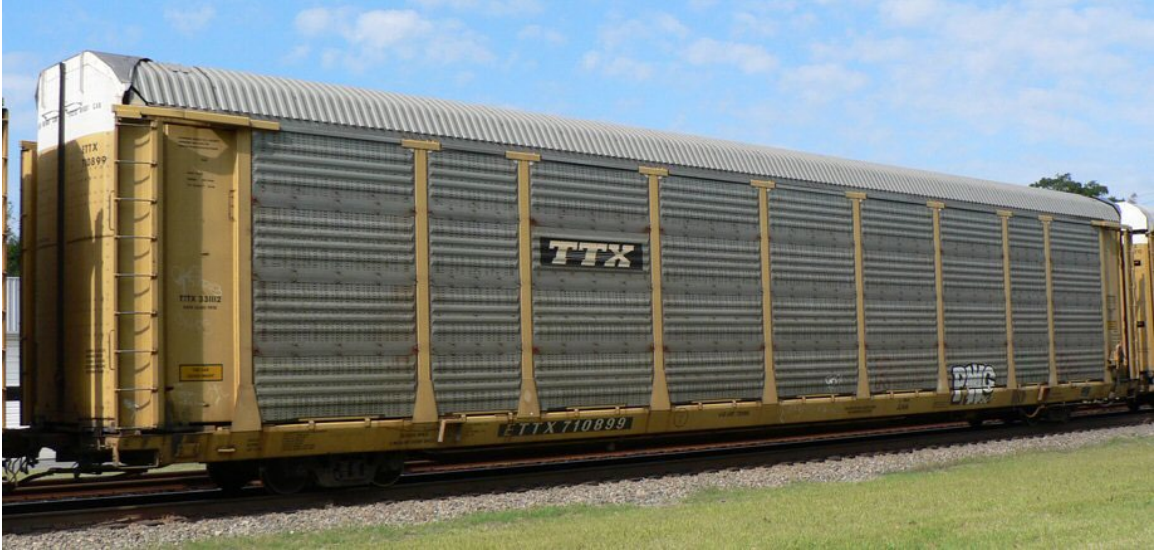
Length over coupler pulling faces	93'-10"
Length over strikers	90'
Distance between truck centers	66'
Width, extreme	10'-8"
Height, extreme	19'
Gross Rail Load	180,000 lb
Light Weight (tare)	100,000 lb



**Figure 16. VAMPIRE Model of a Bi-level Autorack Car**

### **2.10.2 Tri-level Autorack Car**

This type of freight car accommodates three decks of sedans or smaller cars. A total of 12 automobiles can be carried in 1 tri-level Autorack car. [Figure 17](#) shows a picture of a tri-level car and [Table 14](#) lists the main specifications. The 70-ton Swing Motion trucks in the tri-level car have 28-inch diameter wheels to provide for adequate vertical clearance in operation.



**Figure 17. Tri-level Autorack Car**

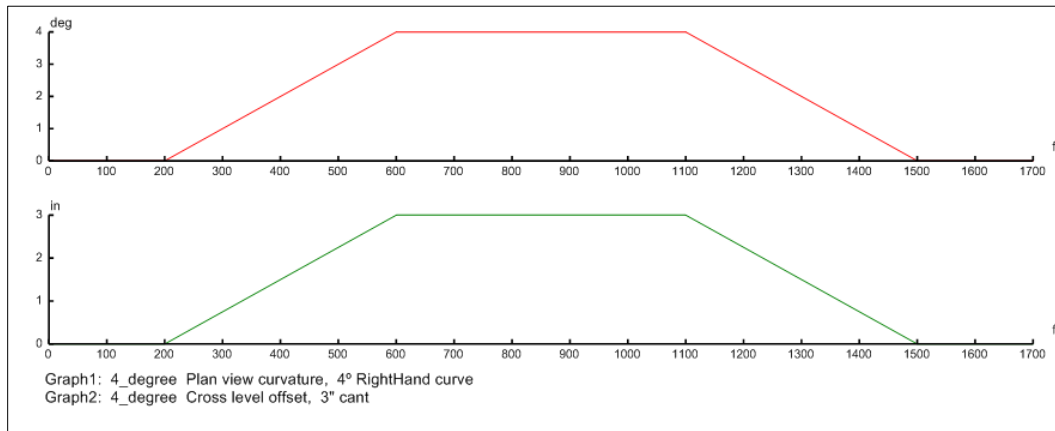
**Table 14. Tri-level Autorack Car Specifications**

Length over coupler pulling faces	93'-10"
Length over strikers	90'
Distance between truck centers	66'
Width, extreme	10'-8"
Height, extreme	19'
Gross Rail Load	179,000 lb
Light Weight (tare)	105,800 lb

### 3. Track Geometry

#### 3.1 Constant Curve Design

As mentioned in [Section 1.2](#), VAMPIRE input files were created for track with 2 to 10 degrees of curvature. The design curve layout as represented in VAMPIRE for a 4-degree curve with the cant (i.e., superelevation) is shown in [Figure 18](#). The X (i.e., horizontal) axis in the plot is the distance along the track. The initial 200 feet of track is a tangent (i.e., straight) section. The entry spiral is 400 feet long (from 200 to 600 feet along the X axis). The full body of the curve is 500 feet long, and the length of the exit spiral is 400 feet. The exit spiral is followed by 200 feet of tangent track. The cant is shown in green. The maximum cant is 3 inches in the full body of the 4-degree curve. The balance speed for this curve is 34 mph. [Table 15](#) shows the combination of curves and cant for the VAMPIRE track models with the corresponding balance speeds. The lengths of the tangents, spirals, and curves are the same in all cases.



**Figure 18. VAMPIRE Plots for Curvature and Superelevation for a 4-Degree Curve**

**Table 15. Curves for VAMPIRE**

Curvature (degree)	Cant (inch)	Balance Speed (mph)
2	0.75	24
4	3	34
6	3.5	30
8	3.5	26
10	2.75	20

The constant curves in this section have ideal geometry for curvatures and cant without measured track perturbations. Another set of models created for the track library included measured track irregularities (see [Section 3.2](#)).

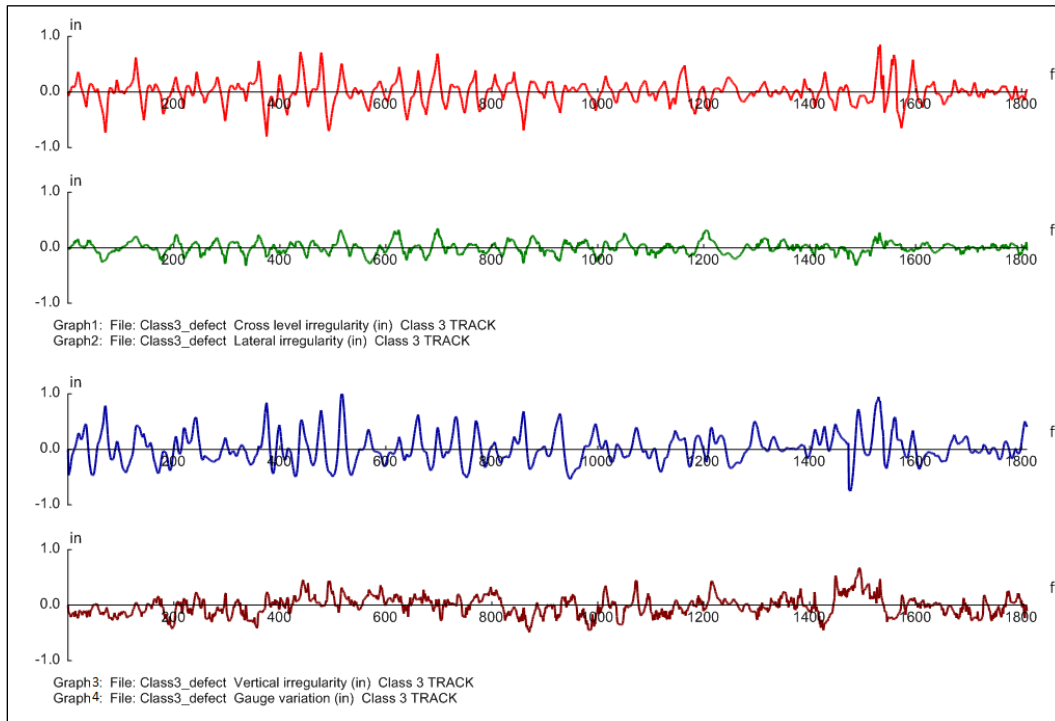
#### 3.2 Track Irregularities

To enable more realistic prediction of the dynamic response of the freight cars from the VAMPIRE simulations, the research team developed an additional set of VAMPIRE track models in which measured vertical and lateral irregularities were superimposed over the ideal curve and cant geometry described in [Section 3.1](#). The measured irregularities were typical of track maintained to Class 3 and Class 4 standards. In all cases, the maximum irregularities did

not exceed the allowable safety standards. Researchers performed simulations using the Class 3 track irregularities for this project, and the track model with the Class 4 track irregularities is for use with any potential derailment investigations in the future.

### 3.3 Typical FRA Class 3 and Class 4 Track Geometry Defects

Figure 19 shows a sample plot of the cross level, lateral, and vertical space curves for a section of FRA Class 3 track at which the maximum track speed is 40 mph. VAMPIRE simulations were run for three speeds on each curve: 1.5 inch under balance, at balance, and 1.5 inch over balance conditions. When the speed corresponding to 1.5 inch over balance condition exceeded the allowable track speed of 40 mph on a specific curve, the simulation was run at the maximum permissible speed of 40 mph.



**Figure 19. Class 3 Track Irregularities**

#### 3.3.1 Class 3 Vertical Irregularity

**Profile:** This parameter relates to elevation of either rail along the track. When trains encounter short dips or humps in the track, it can result in vertical separation of couplers, broken springs, etc. Humps and dips in the track result from differential settlement of the ballast and substructure.

The blue colored plot in Figure 19 shows a sample of the measured profile (i.e., vertical irregularity) from a section of track maintained to FRA Class 3 track standards. This plot was obtained by averaging the left rail and right rail profile irregularities at each measurement location.

**Crosslevel:** This parameter is the difference in height between the top surfaces of one rail and that of the opposite rail at the same location. The red line in [Figure 19](#) shows the cross level measured from a section of track maintained to FRA Class 3 standards.

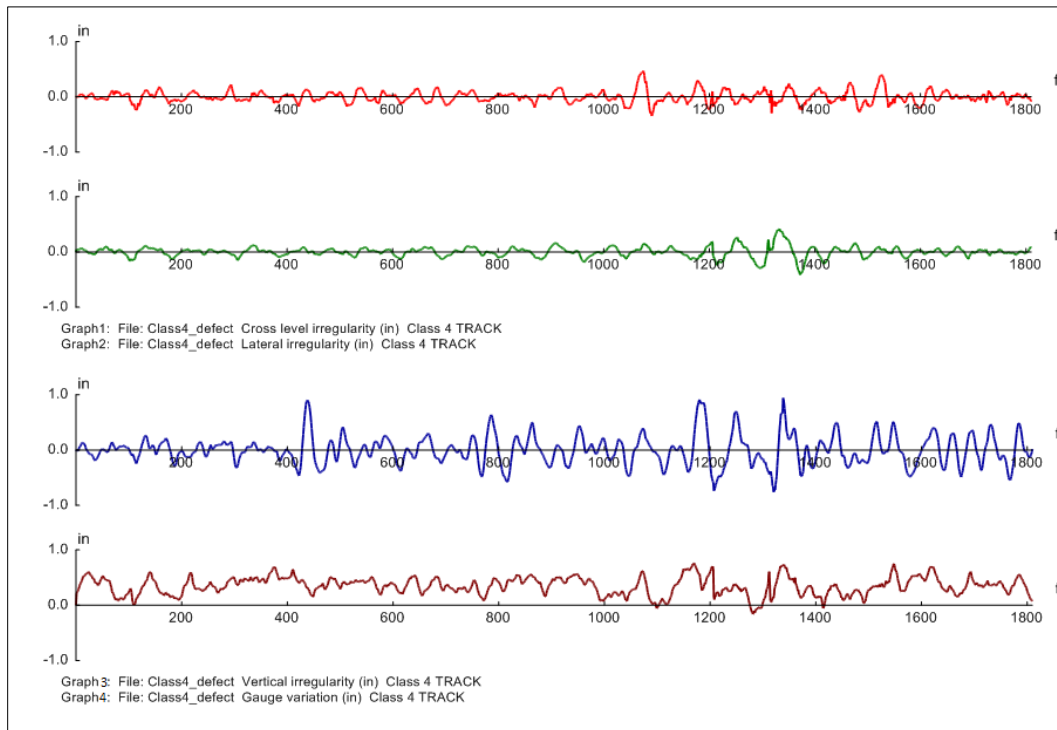
### 3.3.2 Class 3 Lateral Irregularity

**Alignment:** Alignment is the variation in curvature of each rail of the track. On tangent track, the intended curvature is zero and the alignment is measured as the variation (i.e., deviation) from zero. In a curve, the alignment is measured as variation from “uniform” alignment over a specified distance. The green line in [Figure 19](#) shows the lateral irregularity or alignment for a sample section of Class 3 track.

**Gauge:** Gauge is measured between the rail heads at right angles to the longitudinal track axis on a plane 5/8 inch below the top of the rail head. The nominal gauge is 56.5 inch.

### 3.3.3 Class 4 Irregularity

[Figure 20](#) shows a sample plot of the cross level, lateral, and vertical space curves for a section of FRA Class 4 track. The maximum track speed for FRA Class 4 track is 60 mph.



**Figure 20. Class 4 Track Irregularities**

## 4. Wheel and Rail Profiles

Wheel and rail profiles play an important role in vehicle and track interaction forces, with pronounced effects on the tendency of a wheel to climb the rail during curve negotiation.

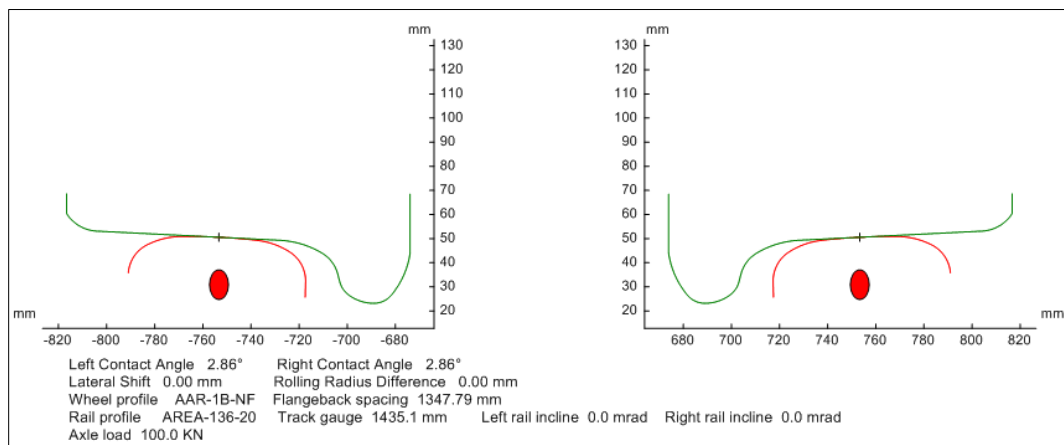
The recommended profile for new wheels over the last two decades has been AAR-1B, which recently was replaced by AAR-2A. The rail section used in main line track in the North American network is American Railway Engineering and Maintenance of way Association (AREMA) 136. Since track is typically laid with a 1 in 20 or 1 in 40 cant, the research team developed VAMPIRE input files for wheel/rail profile combinations having both 1 in 20 and 1 in 40 cant angles and performed simulations for combinations with 1 in 20 cant angle for this report. The input file for wheel/rail profiles with 1 in 40 cant angle will be used as needed for any potential derailment investigation in the future.

### 4.1 Wheel

The recommended new wheel profiles were developed by AAR based on a worn profile that is stable for most of its service life. It should be noted that not all railroads have the same route characteristics and car loading patterns, since the stable profile is governed by the presence and severity of curves on a railroad. Eastern railroads have more frequent and higher degree curves than western railroads, so the nominal stable worn profile for the two regions is likely to be different even when the wheel loads are the same.

#### 4.1.1 AAR-1B Wheel Profile

The AAR-1B profile was developed in the 1980s from measured worn profiles. The wheel has a 1:20 tread taper and 75-degree flange angle. Wheels with this profile exhibited improved curving performance and rolling resistance but lower hunting threshold in comparison to a standard AAR 1:20 profile. [Figure 21](#) shows a plot of the AAR 1-B wheel profile with a narrow flange.



**Figure 21 AAR-1B Narrow Flange Wheel Profile on AREMA 136-20 Rail Profile**

Until recently, the AAR-1B profile was the recommended profile for interchange service in North America. Most of the cars in revenue service most likely are running with wheels having AAR 1-B profiles. The team developed VAMPIRE input files for wheels having AAR 1-B profiles with narrow and wide flanges.

### 4.1.2 AAR-2A Wheel Profile

The AAR-2A profile was introduced into revenue service in 2018 and is currently recommended for freight cars in interchange service. The profile was developed in the 2000s from measured worn wheel profiles. The wheel has a 1:20 tread taper and 75-degree flange angle. The flange thickness of the 2A profile is about 1/8 inch less than the 1B profile. The 2A profile has shown improvement in high speed stability and curving performance when compared to the 1B profile. It provides more conformal contact during flange contact in curves, achieving lower wheel wear. Figure 22 shows the contact locations for the AAR-2A wheel profile with AREMA 136 rail profile having 1 in 20 rail cant.

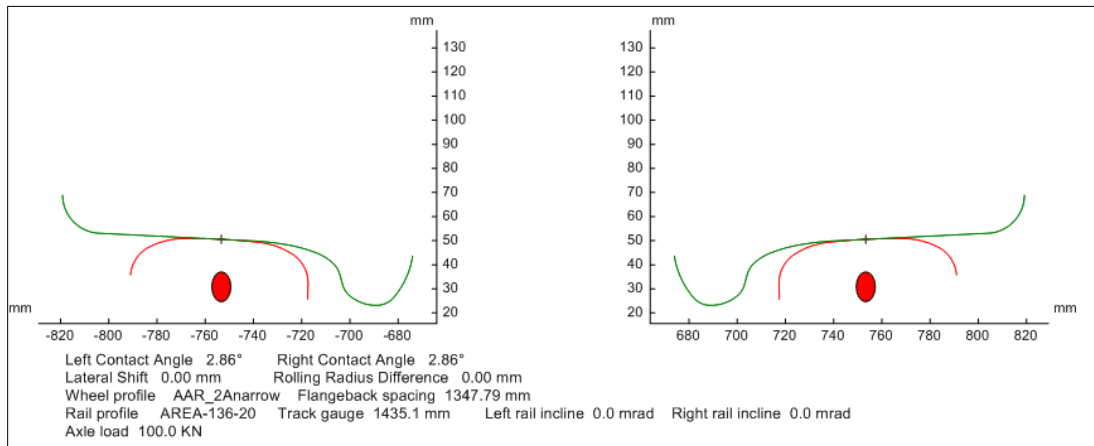


Figure 22. AAR-2A Wheel Profile on AREMA 136-20 Rail Profile

### 4.1.3 Worn Wheel

Researchers generated the VAMPIRE input file for a hollow worn wheel profile. Figure 23 shows the plot for the worn profile with 2 mm of hollow tread on an AREMA 136 rail profile.

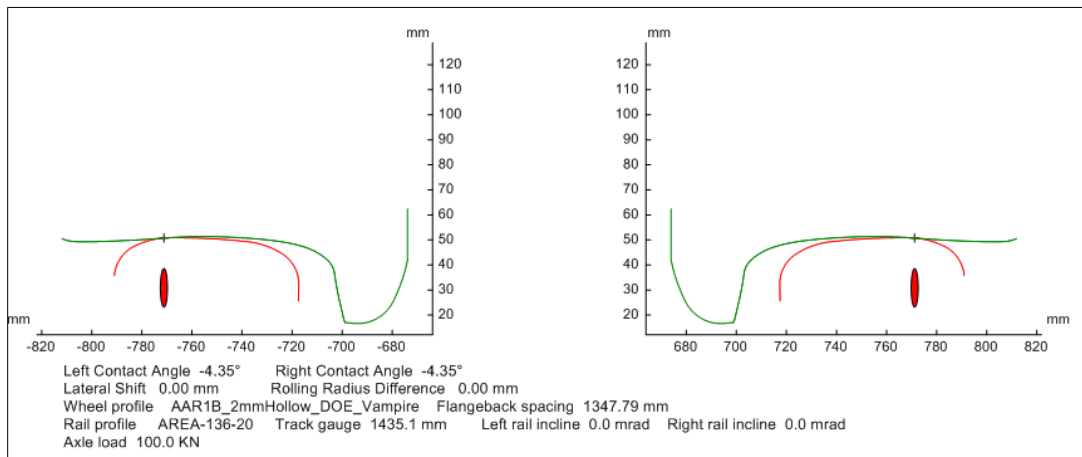


Figure 23. Hollow Worn Wheel Profile on AREMA 136-20 Rail Profile

## 4.2 Rail

The rail profiles commonly used in the industry comply with AREMA standards. The research team developed VAMPIRE input files for two of the profiles as described below. New rail



profiles were assumed in both cases. Input files for the wheel/rail profile were created for both new and worn rail profiles. The AREMA 136 new rail input profile was used for the simulations discussed in this report. The input files with other rail profiles will be used as needed for any potential derailment investigation in the future.

#### **4.2.1 AREMA 132**

The AREMA 132 rail profile data for generating contact geometry files are available for both 1 in 20 and 1 in 40 rail cant.

#### **4.2.2 AREMA 136**

The AREMA 136 rail profile data for generating contact geometry files are available for both 1 in 20 and 1 in 40 rail cant.

### **4.3 Summary**

The AAR-2A profile is now mandatory on new cars and used when replacing repaired axles. However, most freight cars in service are operating with AAR-1B wheels. Therefore, the team used the wheel/rail contact geometry file for the combination of AAR-1B (narrow flange) wheel profile with the new AREMA 136 rail profile (1 in 40 cant) for the example VAMPIRE simulations discussed in [Section 5](#) and all the example vehicle dynamics simulations in this report. The team also developed VAMPIRE input files for additional wheel/rail profile combinations including worn profiles to simulate a specific derailment scenario as needed.



## 5. Vehicle Dynamics Simulation Results

Table 16 provides a list of car types and simulation scenarios for which VAMPIRE models were developed for this project. The car type and track model combinations the team evaluated are indicated with an “X” in the table. This section presents the response of four different car types negotiating curve sections with and without Class 3 track irregularities. A friction coefficient of 0.2 at the interface between the carbody center plate and truck center bowl was used in the simulations. As mentioned, the contact file using the AAR-1B wheel and AREMA 136 rail profile combination was used for the simulation results discussed in this report. Contact files for other wheel/rail profile combinations can be generated as needed, including worn wheel and rail profiles.

**Table 16. Simulation Matrix**

Car type		2 degree		4 degree		6 degree		8 degree		10 degree	
		constant	w/ class 3 perturbation	constant	w/ class 3 perturbation	constant	w/ class 3 perturbation	constant	w/ class 3 perturbation	constant	w/ class 3 perturbation
Box	Loaded (L)										
	Empty (E)										
	L/E with Coupler force										
Equipped Box	Loaded (L)										
	Empty (E)										
	L/E with Coupler force										
Covered Hopper	Loaded (L)	X		X	X	X	X	X		X	
	Empty (E)	X		X	X	X	X	X		X	
	L/E with Coupler force										
125-ton Hopper Car	Loaded (L)										
	Empty (E)										
	L/E with Coupler force										
Open Top Hopper	Loaded (L)										
	Empty (E)										
	L/E with Coupler force										
Gondola	Loaded (L)										
	Empty (E)										
	L/E with Coupler force										
Flat	Loaded (L)										
	Empty (E)										
	L/E with Coupler force										
3 pack Intermodal Car	Loaded (L)	X		X	X	X	X	X		X	
	Empty (E)	X		X	X	X	X	X		X	
	L/E with Coupler force										
5 pack Intermodal Car	Loaded (L)										
	Empty (E)										
	L/E with Coupler force										
Tank car	Loaded (L)	X		X	X	X	X	X		X	
	Empty (E)	X		X	X	X	X	X		X	
	L/E with Coupler force			X		X					
Autorack (Bi-Level)	Loaded (L)	X		X	X	X	X	X		X	
	Empty (E)	X		X	X	X	X	X		X	
	L/E with Coupler force										
Autorack (Tri-Level)	Loaded (L)										
	Empty (E)										
	L/E with Coupler force										

### 5.1 Criteria for Assessment

Car responses were assessed in terms of safety criteria for the wheel L/V ratio of the leading high rail wheel and the truck side L/V ratio for the high rail of curve sections and wheel unloading (AAR M-1001 Specification, 2020). The criteria listed below were used to analyze the response of the various freight cars.

### 5.1.1 Wheel L/V Ratio

Wheel L/V is considered an indicator of a wheel tendency to climb the rail. Wheel L/V ratio exceeding a value of 1.0 for duration greater than 50 ms and distance greater than 3 feet per instance indicates a propensity for the wheel to climb the rail.

### 5.1.2 Truck Side L/V

Truck side L/V is the ratio of the sum of the *lateral* forces on two wheels on one side of the truck to the sum of the *vertical* forces on the same two wheels. Truck side L/V ratio exceeding a value of 0.6 for a duration equivalent to 6 feet per instance indicates a propensity for rail rollover.

### 5.1.3 Minimum Vertical Load (% Wheel Unloading)

Another safety criterion used in the assessment of dynamic performance of a railway vehicle is minimum vertical load on a wheel as a percentage of the static wheel load. A value below 10 percent for a duration greater than 50 ms and distance greater than 3 feet per instance indicates a propensity for wheel lift.

All simulation results discussed in the following section have been filtered at 15 Hz, as specified in AAR M-1001 Specification (2020).

## 5.2 Covered Hopper Car

This section presents the response of the covered hopper car negotiating curve sections with and without Class 3 track irregularities.

### 5.2.1 Steady State Curve (No Perturbations)

Figure 24 shows the wheel L/V ratios for the high rail wheel of the leading axle of a loaded covered hopper car negotiating a 6-degree curve. The L/V ratios for 1.5 inch of under-balance at 23 mph and the balance speed of 30 mph are slightly higher than the ratio at 1.5 inch of over balance. This is because the higher vertical load on the high rail at 35 mph corresponding to 1.5 inch of over balance causes a lower wheel L/V ratio. For all three speeds, the maximum wheel L/V ratio is much lower than the AAR limit value of 1.0.

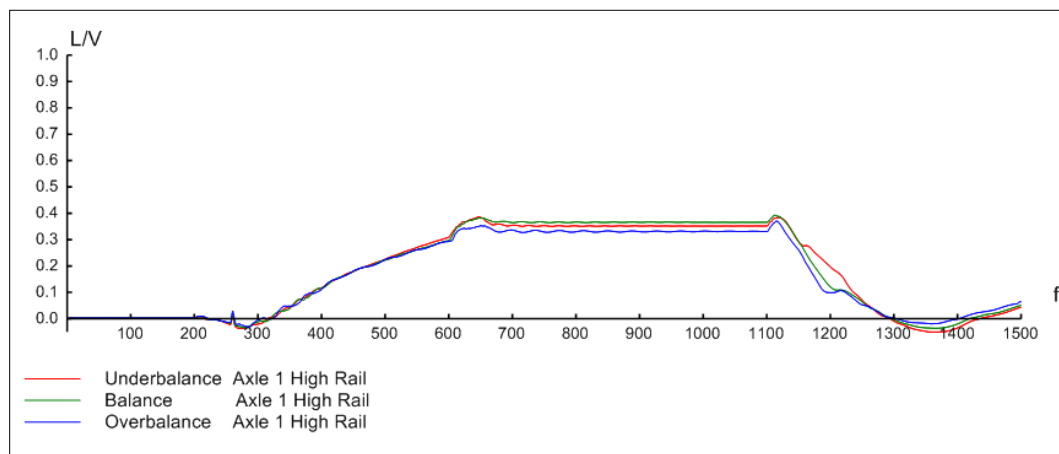
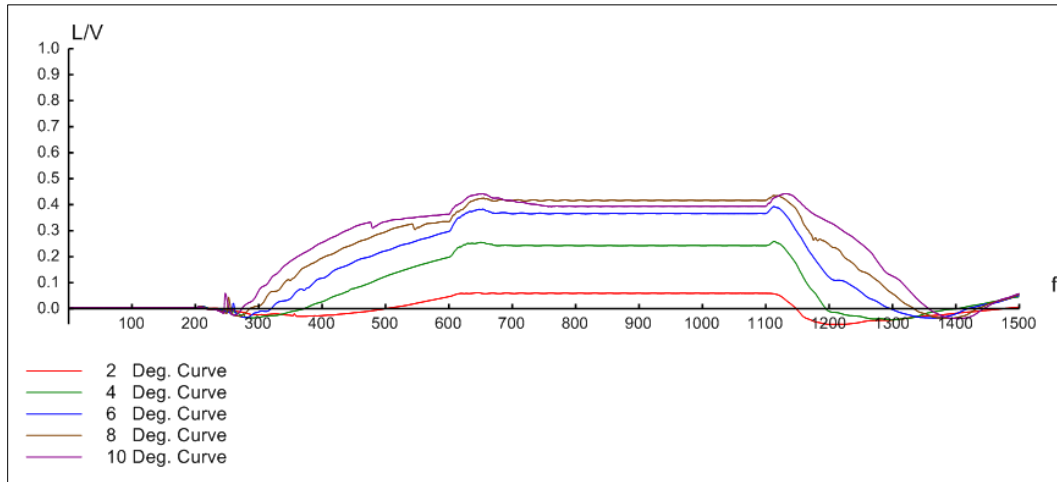


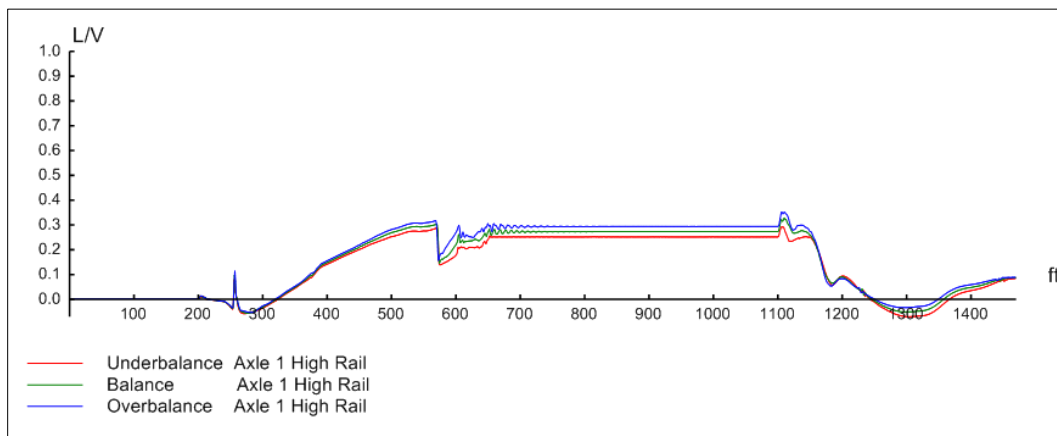
Figure 24. Wheel L/V Ratio for Loaded Covered Hopper Car on a 6-Degree Curve

Figure 25 shows the high rail wheel L/V ratios at the balance speeds over a range of curvatures from 2 to 10 degrees in 2-degree increments. The results follow the expected trend of L/V ratios to increase with the increase in curvatures (i.e., smaller radii curves). As the radius of curve decreases, the leading axle angle of attack increases and results in an increase in the L/V ratio.



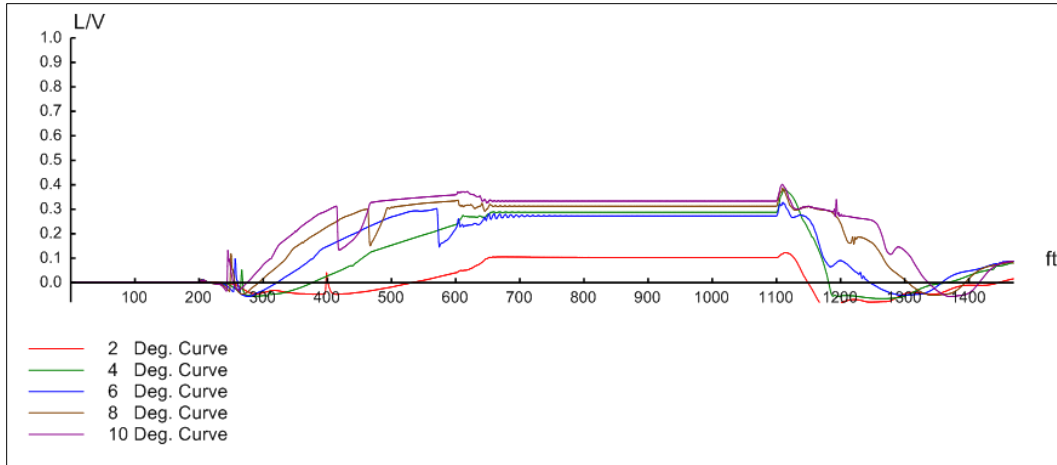
**Figure 25. Wheel L/V Ratios Over a Range of Curves at Balance Speeds (Loaded Covered Hopper Car)**

Figure 26 shows the wheel L/V ratio for an empty covered hopper car negotiating a 6-degree curve. The wheel L/V ratio of 0.35 for the over balance speed of 35 mph is slightly higher than the other two cases because of the effect of higher centrifugal force as the empty car negotiates the curve.



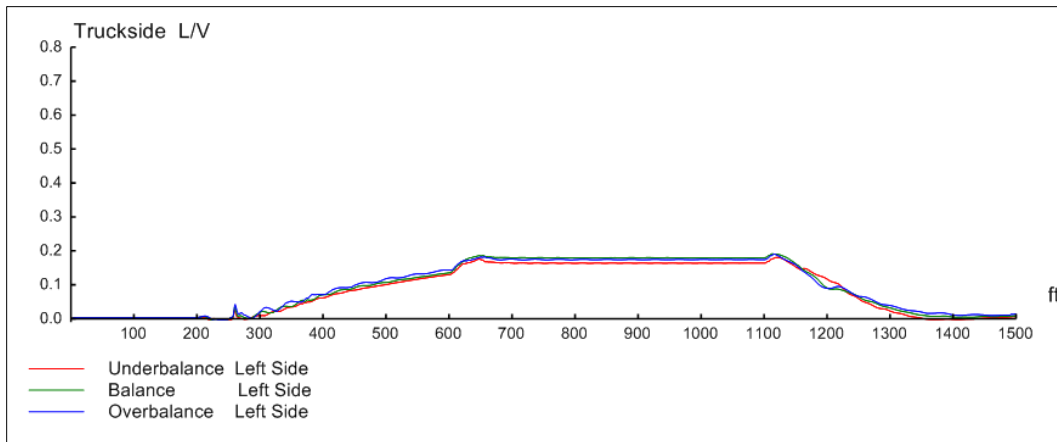
**Figure 26. Wheel L/V Ratio for Empty Covered Hopper Car**

Figure 27 plots the high rail wheel L/V ratios at balance speeds over a range of curvatures for an empty covered hopper car. The prediction follows the expected trend of higher wheel L/V ratio as the degree of curvature increases. The increase in L/V ratio when the curve changes from 2 to 4 degrees is greater than when the curve changes from 6 to 8 and from 8 to 10 degrees. This is due to the lead axle high rail wheel starting to flange between 2 and 4 degrees.

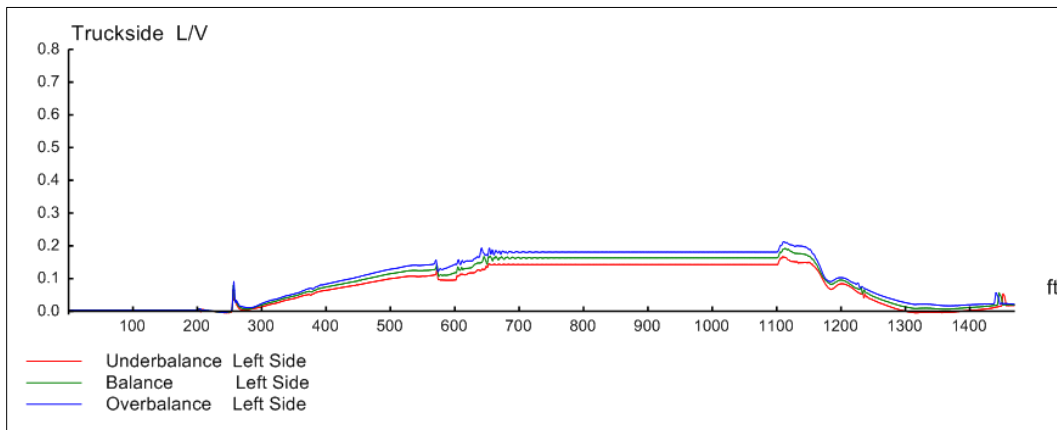


**Figure 27. Wheel L/V Ratios Over a Range of Curvatures at Balance Speeds (Empty Covered Hopper Car)**

The truck side L/V ratios on the high rail of the 6-degree curve for three speeds of 1.5 inch under balance, at balance, and 1.5 inch over balance are shown in [Figure 28](#) for the loaded covered hopper car and in [Figure 29](#) for the empty covered hopper car.



**Figure 28. Truck Side L/V Ratio for Loaded Covered Hopper Car**



**Figure 29. Truck Side L/V Ratio for Empty Covered Hopper Car**

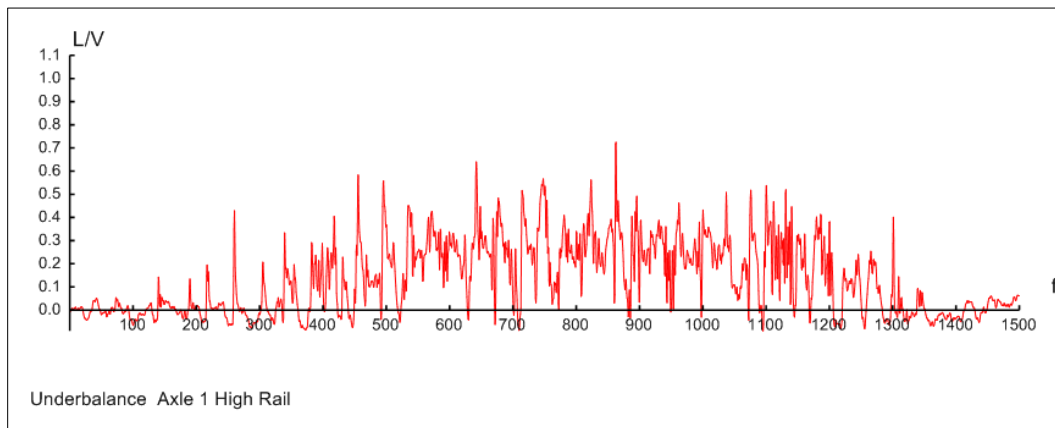
Table 17 summarizes the results of simulations with both the empty and loaded covered hopper car negotiating a range of curves from 2 to 10 degrees without track perturbations. The values shown are the maximum among 1.5 inch under balance, at balance, and 1.5 inch over balance speed results for each curvature. The maximum values are all within the limits required by the AAR M-1001 standard.

**Table 17. Predicted Covered Hopper Car Response (Maximum Values from the Three Speeds, Steady State Curve)**

Criterion	Curvature, degrees					AAR M-1001 Limit
	2	4	6	8	10	
	Loaded Car					
Maximum Wheel L/V	0.14	0.26	0.39	0.44	0.45	1
Max Truck Side L/V	0.07	0.15	0.19	0.25	0.28	0.6
Min vert wheel load, %	87	80	78	78	79	10
	Empty car					
Maximum Wheel L/V	0.20	0.39	0.35	0.41	0.42	1
Max Truck Side L/V	0.10	0.20	0.29	0.34	0.36	0.6
Min vert wheel load, %	83	74	73	73	75	10

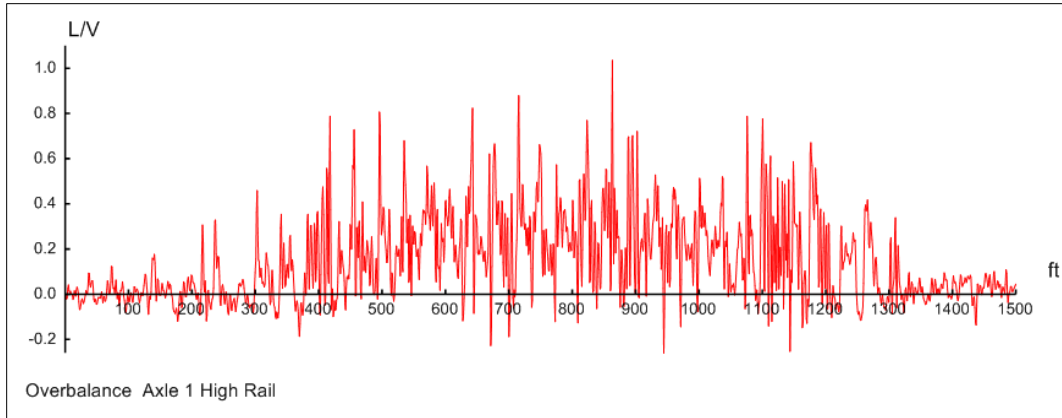
### 5.2.2 Curving with Track Perturbations

FRA Class 3 track perturbations were added to 4- and 6-degree design curves. The team recorded the responses of the loaded and empty hopper cars as they negotiated a 6-degree curve with track perturbations. The maximum wheel L/V ratio was 0.72 for the loaded car negotiating a 6-degree curve with FRA Class 3 track perturbations at 23 mph (1.5 inch under balance) as shown in Figure 30. The maximum value is higher than the predicted value for the steady state curve without perturbations, but less than the AAR allowable L/V ratio of 1.0.

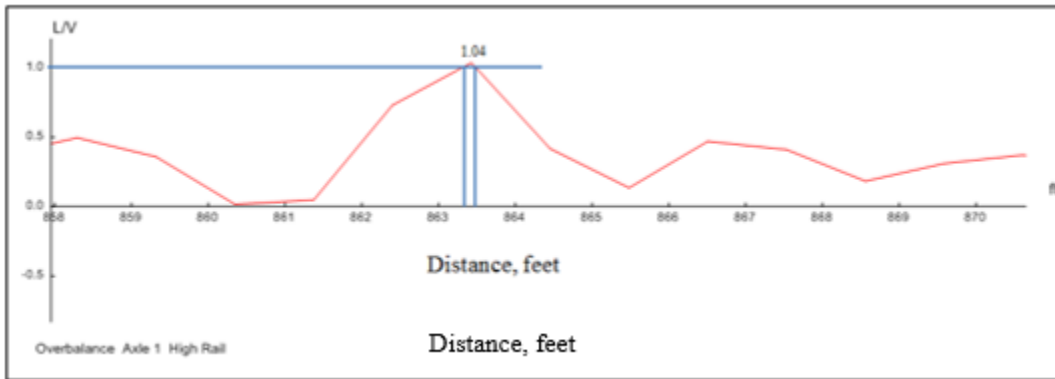


**Figure 30. Wheel L/V Ratio, Loaded Covered Hopper (6-Degree Curve with Perturbation)**

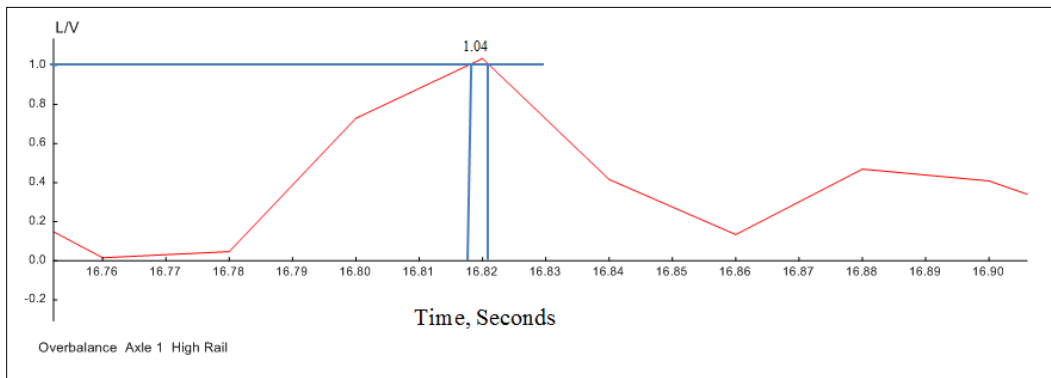
The wheel L/V ratio plot for the empty car negotiating the 6-degree curve at 35 mph (1.5 inch over balance) with track perturbations is shown in Figure 31. The maximum wheel L/V ratio was 1.04. As shown in Figure 32, the maximum wheel L/V ratio exceeded the AAR Chapter 11 limit of 1.0 for a distance less than 3 feet. Figure 33 shows the maximum wheel L/V ratio exceeded the AAR Chapter 11 limit of 1.0 for a duration of less than 50 ms.



**Figure 31. Wheel L/V Ratio, Empty Covered Hopper Car (6-Degree Curve with Perturbation)**



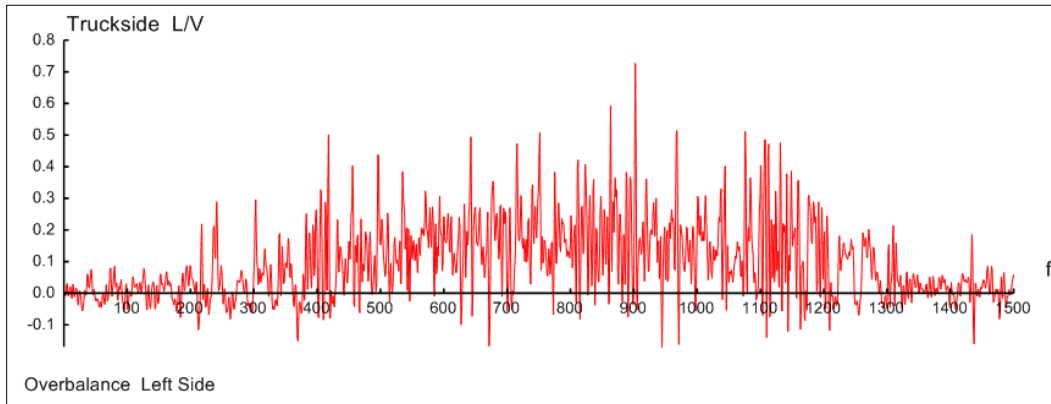
**Figure 32. Exceedance of Maximum Wheel L/V Ratio – Distance Plot (6-Degree Curve with Perturbations)**



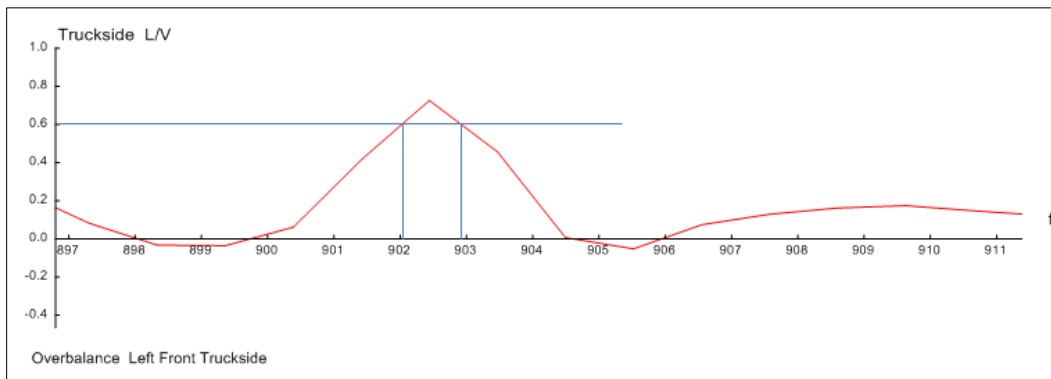
**Figure 33 Exceedance of Maximum Wheel L/V Ratio – Time Plot (6-Degree Curve with Perturbations)**

Figure 34 shows the response in terms of truck side L/V ratio. As per Chapter 11 in the AAR M-1001 standard, the maximum value for a truck side L/V ratio greater than 0.6 is a safety concern if the exceedance is sustained for a distance greater than 6 feet. The maximum value of 0.72 is only for a distance of less than a foot (see Figure 35). Table 18 summarizes the response of the loaded and empty covered hopper cars negotiating curves with track perturbations. The

maximum truck side L/V ratio of 0.59 reported in the table is the second highest value from Figure 34.



**Figure 34. Truck Side L/V Ratio, Empty Covered Hopper Car (6-Degree Curve with Perturbation)**



**Figure 35. Exceedance of Maximum Truck Side L/V Ratio (6-Degree Curve with Perturbation)**

**Table 18. Predicted Covered Hopper Car Response (Track with Perturbations)**

	Curvature, degrees		
	4	6	
Criterion	Loaded Car		AAR M-1001 Limit
Maximum Wheel L/V	0.71	0.72	1
Max Truck Side L/V	0.39	0.39	0.6
Min vert wheel load, %	51	53	10
	Empty car		
Maximum Wheel L/V	0.86	1.0	1
Max Truck Side L/V	0.51	0.59*	0.6
Min vert wheel load, %	34	27	10

\*Second highest value from Figure 34. Refer to Section 5.2.2 for more details.

### 5.3 Three-Unit Double Stack Container Car

Researchers developed models of three- and five-unit multiple platform cars. The end trucks in both models were the same (i.e., 70-ton capacity). The middle trucks (two for the three-unit and four for the five-unit car, respectively) were 125-ton capacity. This section presents the results for the three-unit cars.

#### 5.3.1 Steady State Curve (No Perturbations)

The wheel L/V ratios for the high rail wheel of the leading axle of the end truck for a loaded 3-unit articulated container car negotiating a 6-degree curve are shown in Figure 36. The plot shows the wheel L/V ratio for 1.5 inch under balance and 1.5 inch over balance speeds. The maximum wheel L/V ratio decreases as the speed increases in the steady state portion of the 6-degree curve because the vertical load on the high rail increases as the speed increases. The maximum wheel L/V ratio meets the allowable limit of 1.0 as required by AAR Chapter 11 (M-1001).

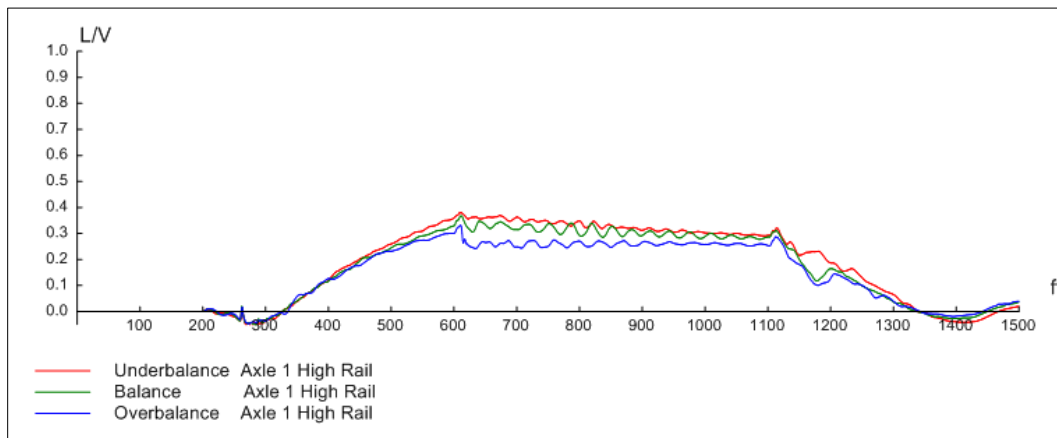


Figure 36. Wheel L/V Ratio for Loaded Three-Unit Container Car (6-Degree Curve)

Figure 37 shows the high rail wheel L/V ratios at the balance speeds over a range of curvatures from 2 to 10 degrees in 2-degree increments. As expected, the magnitude of wheel L/V ratio increases as the curvature value increases.

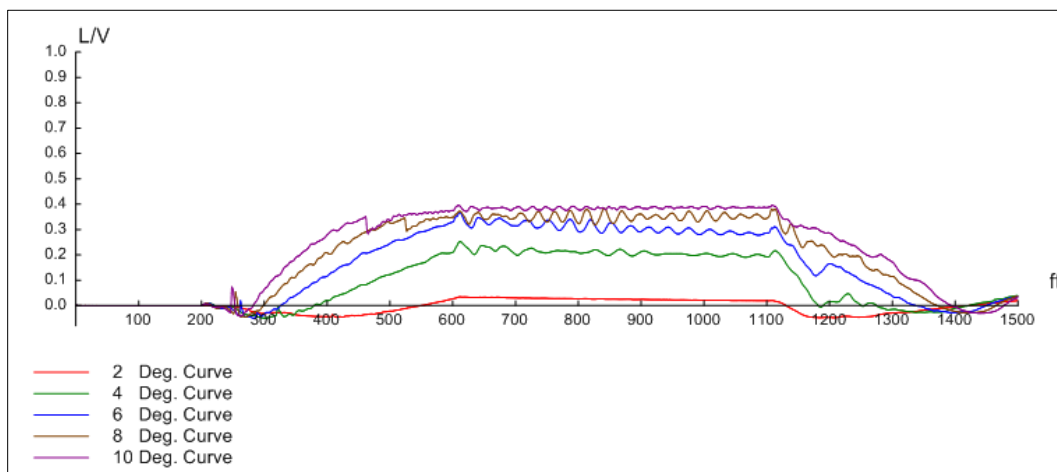
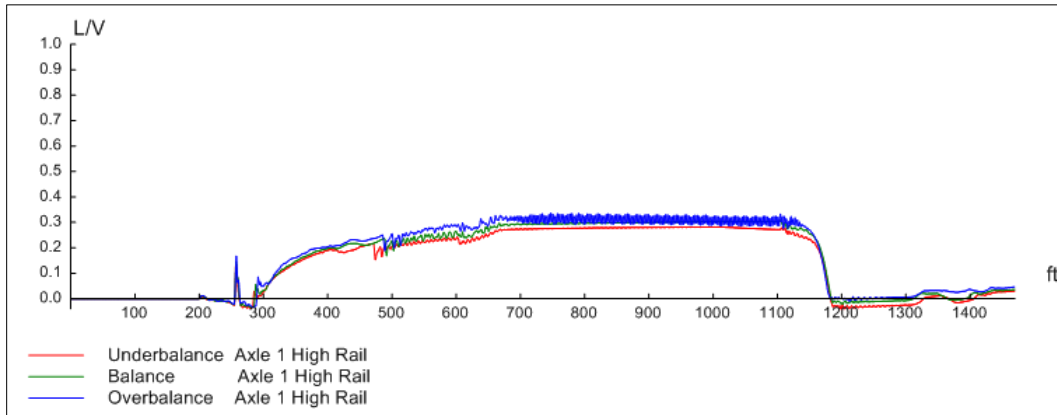


Figure 37. Wheel L/V Ratio Over a Range of Curves (Loaded Three-Unit Container Car)

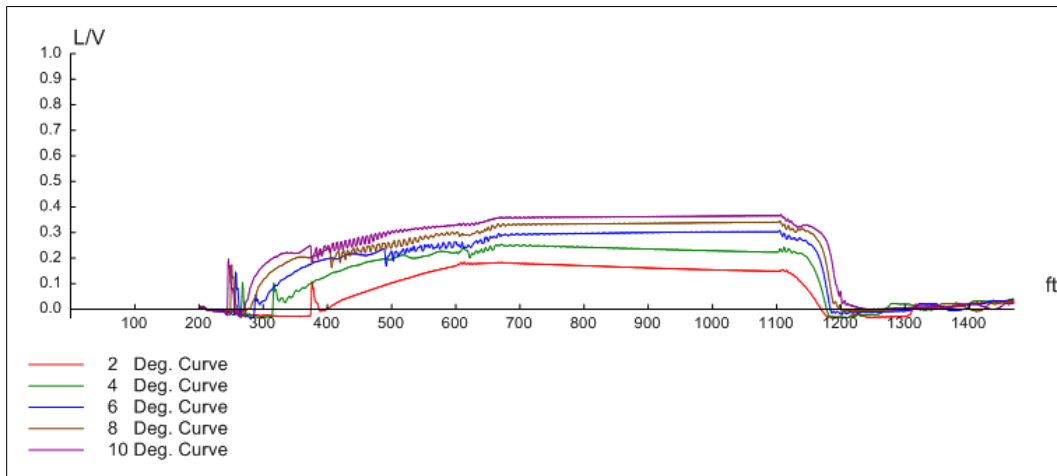


Figure 38 shows the wheel L/V ratio for an empty three-unit articulated car negotiating a 6-degree curve. The trend for the L/V ratio with the increased speed is like that for the empty hopper car. The highest L/V ratio in the steady state curve occurred at 1.5 inch over balance speed.



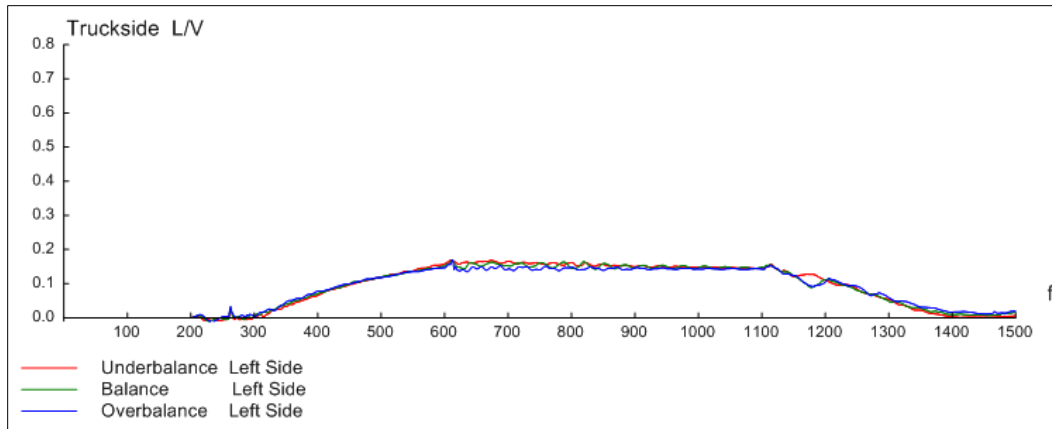
**Figure 38. Wheel L/V Ratio for an Empty, Three-Unit Container Car (6-Degree Curve)**

Figure 39 shows the predicted high rail wheel L/V ratios at the balance speeds for the three-unit articulated car in the empty configuration increased with higher curvature or smaller curve radius.

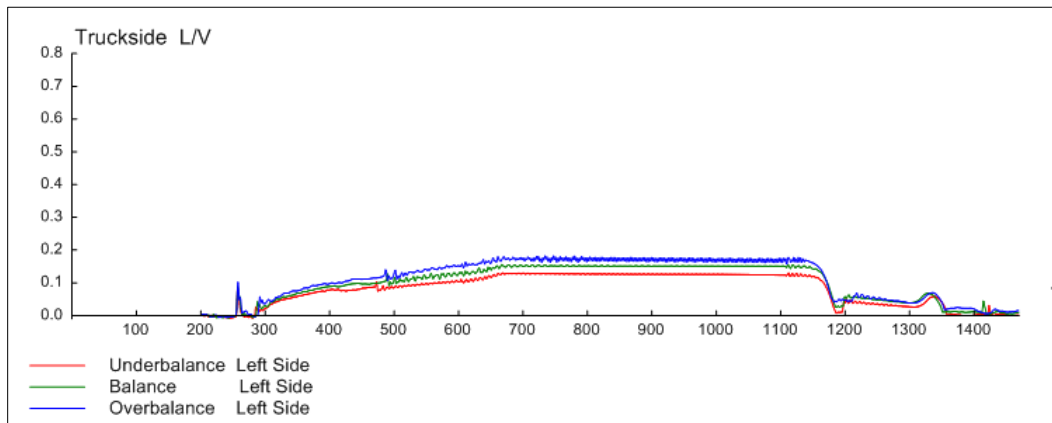


**Figure 39. Wheel L/V Ratios Over a Range of Curvatures (Empty Three-Unit Car)**

Figure 40 and Figure 41 plot the truck side L/V ratios for the loaded and empty three-unit articulated cars. Table 19 summarizes the results for the loaded and empty 3-unit container car negotiating a range of steady state curves from 2 to 10 degrees in 2-degree increments.



**Figure 40. Truck Side L/V Ratio for the Loaded Three-Unit Container Car (6-Degree Curve)**



**Figure 41. Truck Side L/V Ratio for the Empty Three-Unit Container Car (6-Degree Curve)**

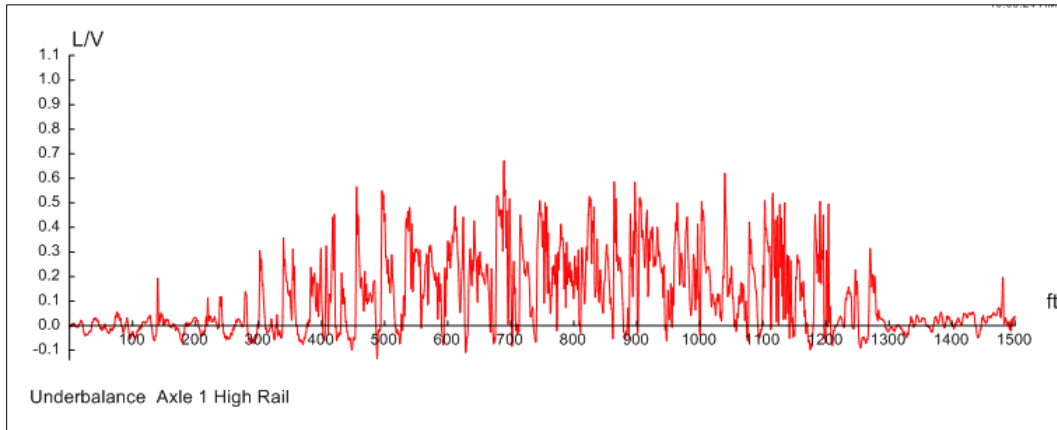
**Table 19. Predicted Three-Unit Container Car Response (Steady State Curve)**

Criterion	Curvature, degrees					AAR M-1001 Limit
	2	4	6	8	10	
	Loaded Car					
Maximum Wheel L/V	0.13	0.26	0.38	0.42	0.45	1
Max Truck Side L/V	0.05	0.14	0.18	0.20	0.23	0.6
Min vert wheel load, %	87	80	78	77	81	10
	Empty car					
Maximum Wheel L/V	0.20	0.35	0.35	0.39	0.41	1
Max Truck Side L/V	0.11	0.22	0.20	0.23	0.28	0.6
Min vert wheel load, %	94	87	86	86	87	10

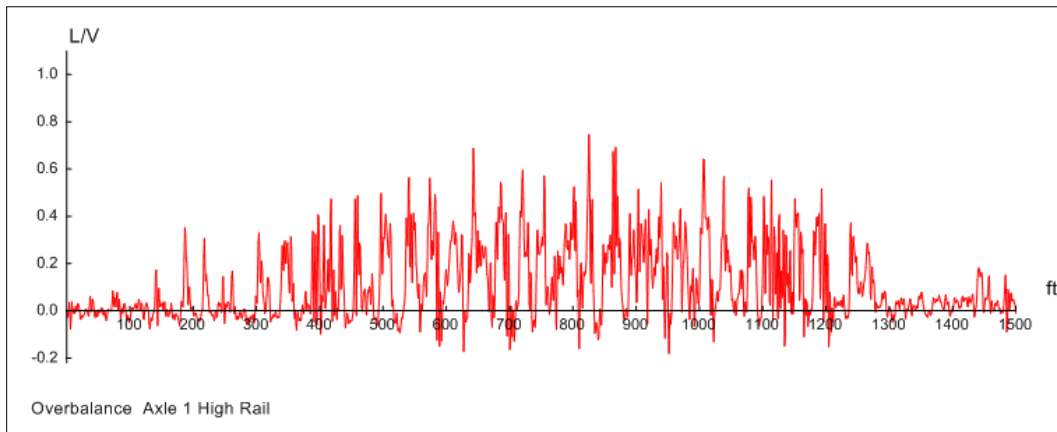
### 5.3.2 Response for Track with Perturbations

Section 3.2 explains FRA Class 3 track irregularities or perturbations added to the 4- and 6-degree design curves. The team recorded the response of the loaded and empty three-unit articulated cars as they negotiated a 6-degree curve with track perturbations. The maximum wheel L/V ratio is 0.69 for the loaded car negotiating a 6-degree curve with FRA Class 3 track

perturbations at 23 mph (1.5 inch under balance) as shown in Figure 42. The maximum value is higher than the predicted value for the curve without perturbations but less than the AAR allowable of 1.0. Figure 43 shows the wheel L/V ratio plot for the empty car going over the 6-degree curve with track perturbations at 35 mph (1.5 inch over balance).

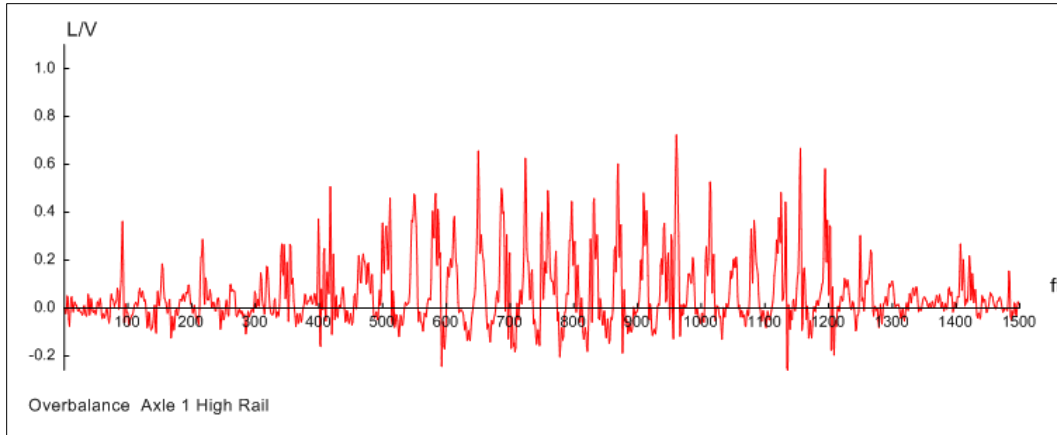


**Figure 42. Wheel L/V Ratio, Loaded Three-Unit Container Car (6-Degree Curve with Perturbation)**

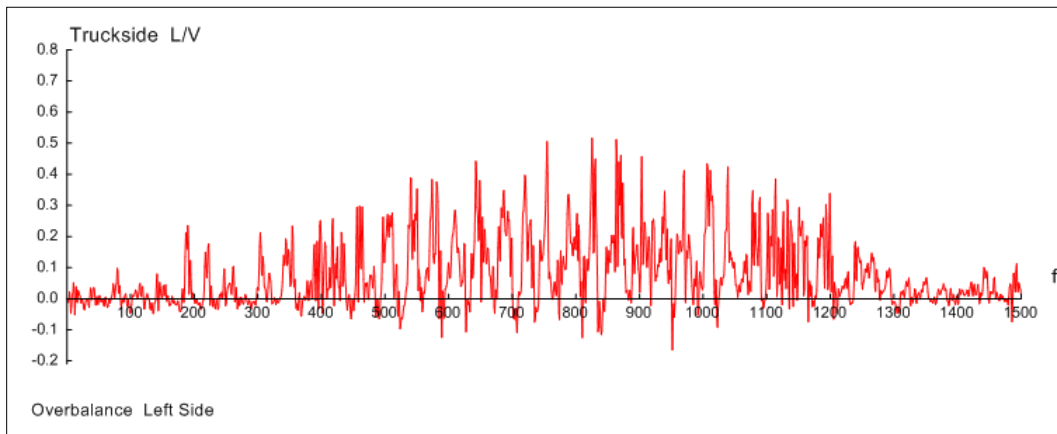


**Figure 43. Wheel L/V Ratio, Empty Three-Unit Container Car (6-Degree Curve with Perturbation)**

The response of the empty three-unit container car over a 4-degree curve at the maximum speed of 40 mph (1.25 inch over balance) for FRA Class 4 track is shown in Figure 44. The peak wheel L/V ratio is 0.81. Figure 45 shows the truck side L/V ratio is above the AAR threshold of 0.6 for a distance of less than 6 feet. The second highest value of 0.55 is reported as the maximum truck side L/V ratio. Following the same methodology, the minimum vertical load as a percentage of the static wheel load reported for this case is the second lowest value of 23 percent. Table 20 lists the responses of the loaded and empty three-unit container cars negotiating curves with track perturbations.



**Figure 44. Wheel L/V Ratio, Empty Three-Unit Container Car (4-Degree Curve with Perturbations)**



**Figure 45 Truck Side L/V Ratio, Empty Three-Unit Container Car (6-Degree Curve with Perturbations)**

**Table 20. Predicted Three-Unit Container Car Response (Track with Perturbations)**

	Curvature, degrees		
	4	6	
Criterion	Loaded Car		AAR M-1001 Limit
Maximum Wheel L/V	0.61	0.69	1
Max Truck Side L/V	0.33	0.36	0.6
Min vert wheel load, %	54	55	10
	Empty car		
Maximum Wheel L/V	0.81	0.76	1
Max Truck Side L/V	0.55*	0.55	0.6
Min vert wheel load, %	23**	43	10

\* Second highest value. Refer to [Section 4.2.2](#).

\*\* Second lowest value. Refer to [Section 4.2.2](#).

## 5.4 Tank Car

### 5.4.1 Steady State Curve (No Perturbations)

Figure 46 shows the wheel L/V ratios for the high rail wheel of the leading axle of a loaded tank car negotiating a 6-degree curve. The maximum L/V ratios are almost the same for all three speeds and are much lower than the 1.0 limit value per AAR Standard M-1001 (Chapter 11). Figure 47 plots the high rail wheel L/V ratios at the balance speeds over a range of curvatures from 2 to 10 degrees in 2-degree increments. The results follow the expected trend of higher L/V ratios with the increase in curvatures, i.e., smaller radii curves.

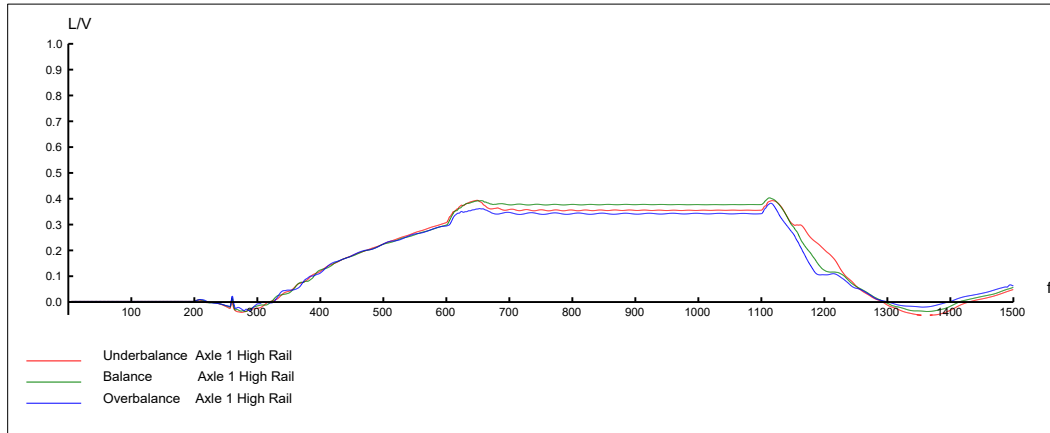


Figure 46. Wheel L/V Ratio for a Loaded Tank Car (Steady State Curve)

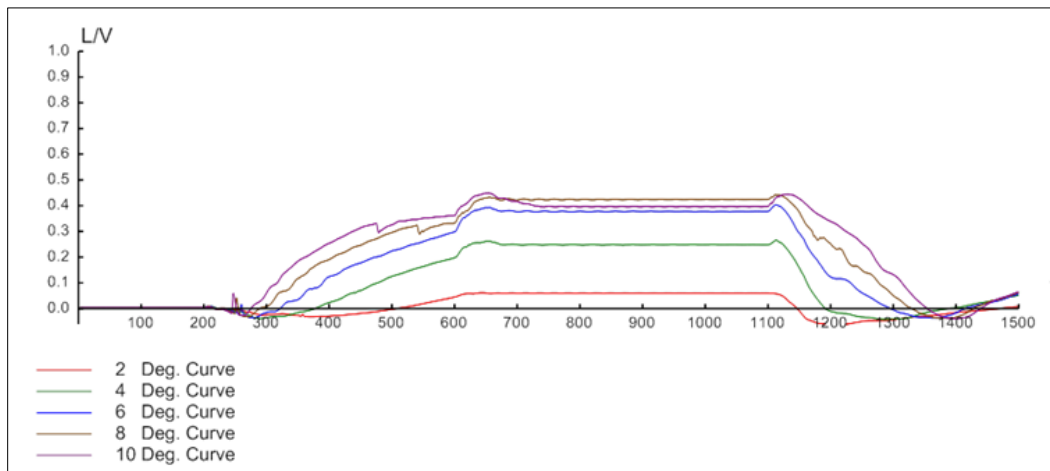
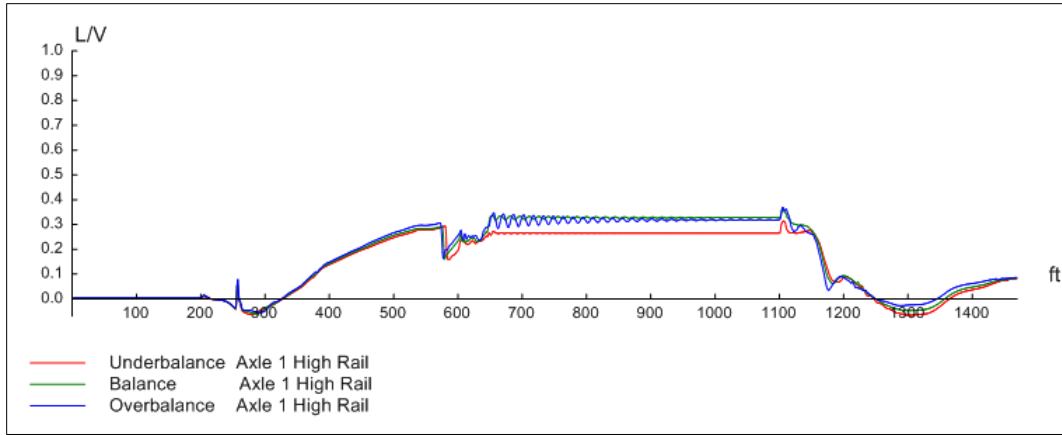


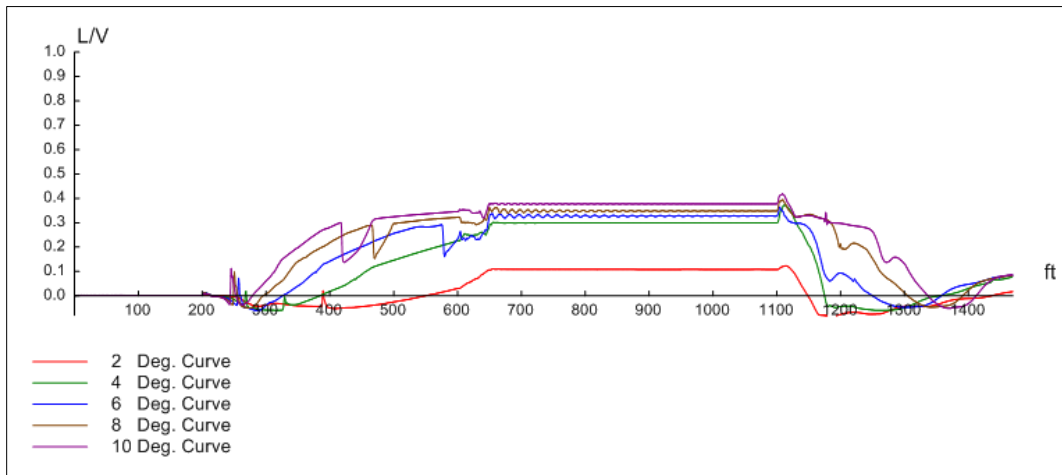
Figure 47. Wheel L/V Ratios Over a Range of Curves (Loaded Tank Car)

Figure 48 shows the wheel L/V ratio for an empty tank car negotiating a 6-degree curve. The trend for the L/V ratio as the speed increases is like that for the empty hopper car. The highest L/V ratio in the steady state curve occurred at 1.5 inch over balance speed.



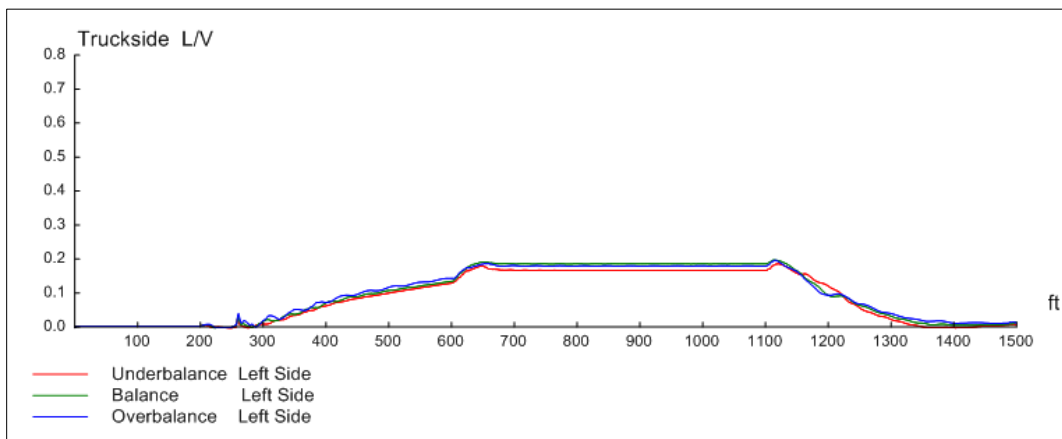
**Figure 48. Wheel L/V Ratio for an Empty Tank Car**

Figure 49 shows that the predicted high rail wheel L/V ratios at the balance speeds for the tank car in the empty configuration increase with higher curvatures.

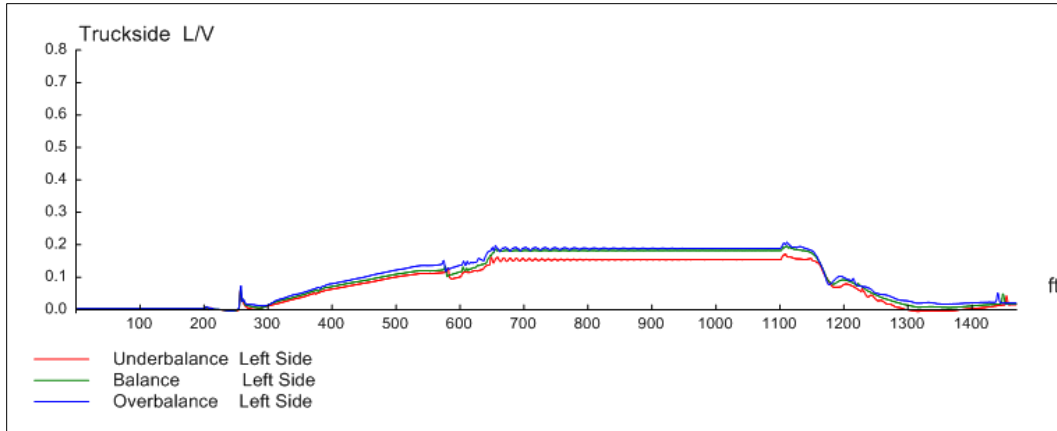


**Figure 49. Wheel L/V Ratios Over a Range of Curvatures (Empty Tank Car)**

Figure 50 and Figure 51 plot the truck side L/V ratios for the loaded and empty tank cars.



**Figure 50. Truck Side L/V Ratio for Loaded Tank Car**

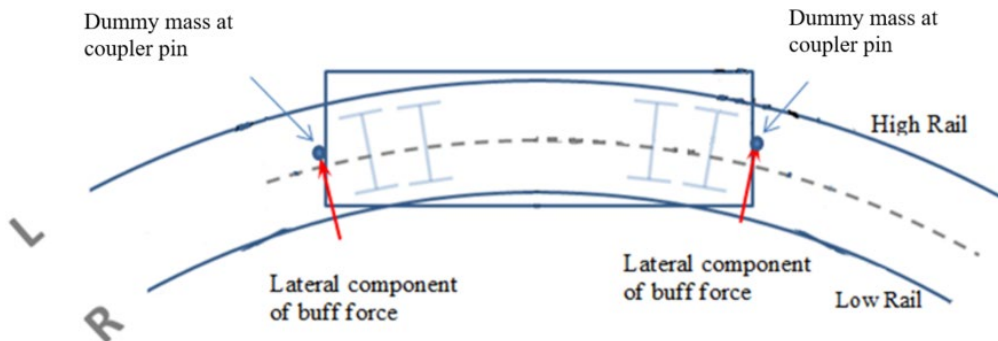


**Figure 51. Truck Side L/V Ratio for an Empty Tank Car**

Section 5.2.1 describes how the maximum truck side L/V ratios for these cases show a trend like that observed for the covered hopper car. The maximum truck side L/V ratios are well below the allowable value of 0.6. Table 21 summarizes the response of the loaded and empty tank car negotiating steady state curves.

**Table 21. Predicted Tank Car Response (Steady State Curve)**

Criterion	Curvature, degrees					AAR M-1001 Limit
	2	4	6	8	10	
	Loaded Car					
Maximum Wheel L/V	0.14	0.26	0.40	0.45	0.46	1
Max Truck Side L/V	0.07	0.15	0.19	0.25	0.28	0.6
Min vert wheel load, %	86	79	77	77	79	10
	Empty car					
Maximum Wheel L/V	0.19	0.37	0.37	0.40	0.43	1
Max Truck Side L/V	0.08	0.18	0.30	0.34	0.36	0.6
Min vert wheel load, %	83	74	72	72	74	10



**Figure 52. Car Model with Lateral Component of Coupler Forces**

To simulate the effect of buff or draft coupler forces, two dummy masses were modelled at the coupler pin and cross key locations in the coupler pockets on both ends of the car. Figure 52 shows the lateral component of coupler forces applied at the fore and aft coupler pin locations. The figure shows the simulation case for buff forces in which the research team directed the



lateral components of the coupler forces toward the high rail of the curve. To simulate the draft forces, the directions of the lateral components were reversed toward the low rail of the curve. The lateral component of the coupler forces varied from 0 to 15 kips in 5-kips increments.

If the in-train forces are high enough, there is a possibility for an empty car to derail due to wheel climb on the high rail from excessive buff force. This situation is referred to as the “jack knife” condition of a car in a curve. The opposite effect of the car potentially derailing on the low rail of the curve (i.e., “string lining”) occurs due to excessive draft forces. Figure 53 shows the wheel L/V ratio plot for the tank car with the lateral component of buff forces through the curve. The wheel L/V ratios on the high rail for a range of lateral coupler forces show that the values are higher in comparison to the curving results without the effect buff forces (see Figure 48) but less than the AAR allowable limit of 1.0. Figure 54 shows wheel L/V ratios on the low rail for an empty tank car negotiating a range of curves with lateral component of draft forces.

Table 22 summarizes the results for a tank car with lateral components of coupler forces going over a 6-degree steady state curve. As expected, wheel L/V ratios increased with higher lateral forces at the coupler. The maximum wheel L/V ratio of around 0.57 occurred for the case of 15 kips of lateral coupler force toward the high rail simulating an empty tank car in buff (i.e., compression) condition through a 6-degree steady state curve.

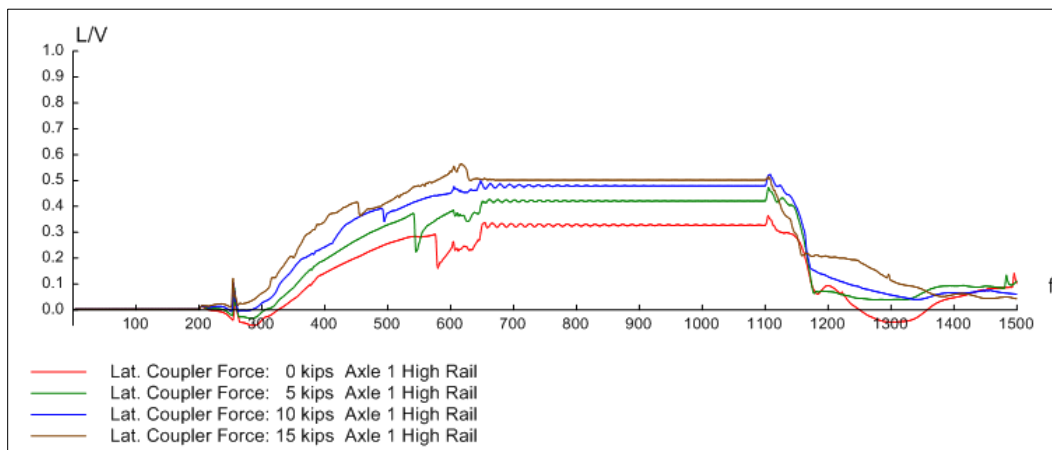


Figure 53. Wheel L/V Ratio, Empty Tank Car, 6-Degree Curve (Buff)

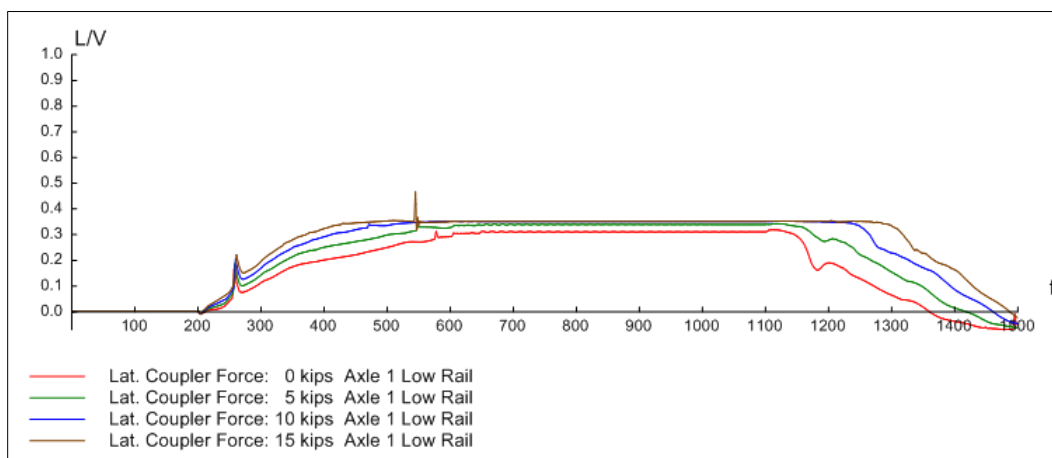


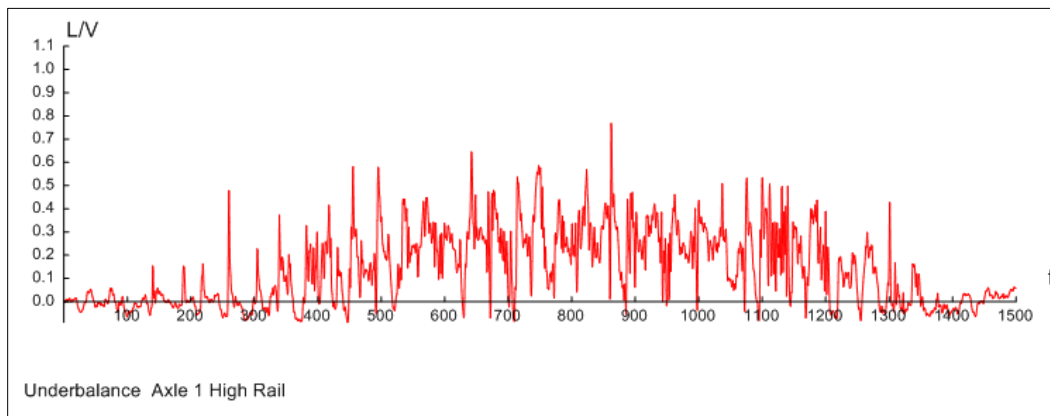
Figure 54. Wheel L/V Ratio, Empty Tank Car, 6-Degree Curve (Draft)

**Table 22. Predicted Tank Car Response on a 6-Degree Steady State Curve (With Coupler Forces)**

Criterion	Lateral Component of Buff Force, Kips				AAR M-1001 Limit
	0	5	10	15	
	Loaded Car				
Maximum Wheel L/V	0.4	0.43	0.45	0.47	1
Max Truck Side L/V	0.2	0.22	0.25	0.28	0.6
Min vert wheel load, %	77	74	72	70	10
Empty car					
Maximum Wheel L/V	0.37	0.49	0.55	0.57	1
Max Truck Side L/V	0.21	0.31	0.41	0.54	0.6
Min vert wheel load, %	72	65	55	43	10
	Lateral Component of Draft Force, Kips				
	0	5	10	15	
	Loaded Car				
Maximum Wheel L/V	0.31	0.32	0.33	0.34	1
Max Truck Side L/V	0.2	0.22	0.24	0.27	0.6
Min vert wheel load, %	77	75	71	68	10
Empty car					
Maximum Wheel L/V	0.32	0.35	0.35	0.47	1
Max Truck Side L/V	0.21	0.3	0.35	0.5	0.6
Min vert wheel load, %	72	71	62	52	10

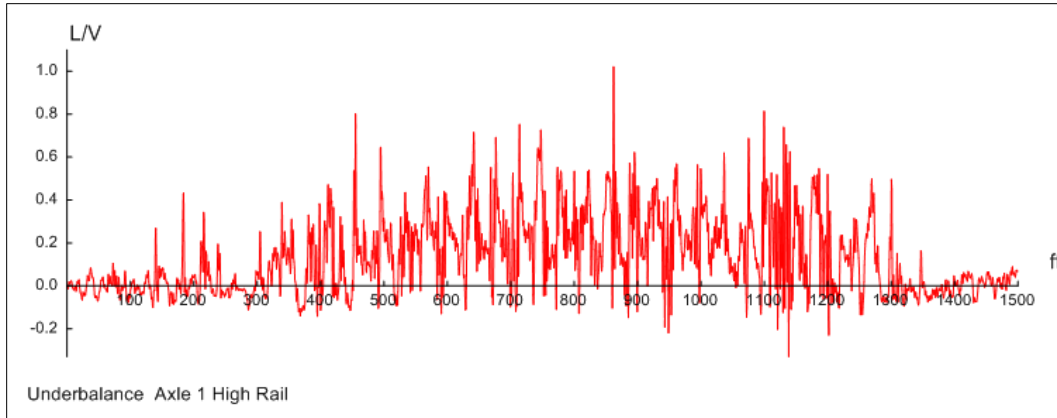
#### 5.4.2 Response for Track with Perturbations

Section 3.2 discussed FRA Class 3 track irregularities or perturbations added to 4- and 6-degree design curves. This section presents the responses of the loaded and empty tank cars as they negotiated a 6-degree curve with track perturbations. Figure 55 shows the maximum wheel L/V ratio is 0.77 for the loaded car negotiating a 6-degree curve with FRA Class 3 track perturbations. The maximum value is higher than the predicted value for the curve without perturbations, but less than the AAR allowable of 1.0.



**Figure 55. Wheel L/V Ratio, Loaded Tank Car (6-Degree Curve with Perturbations)**

Figure 56 shows the wheel L/V ratios for the empty car going over the 6-degree curve with track perturbations. The maximum wheel L/V ratio of 1.0 for an empty tank car negotiating a 6-degree curve with track perturbations is at the limit of AAR Chapter 11 criterion. Table 23 lists the responses of the loaded and empty tank cars negotiating curves with track perturbations.



**Figure 56. Wheel L/V Ratio, Empty Tank Car (6-Degree Curve with Perturbations)**

**Table 23. Predicted Tank Car Response (Curve with Perturbations)**

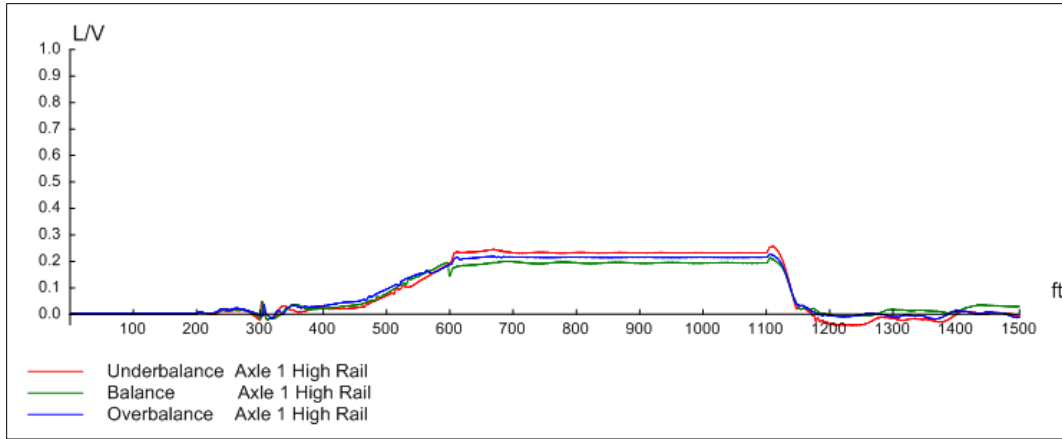
	Curvature, degrees		
	4	6	
Criterion	Loaded Car		AAR M-1001 Limit
Maximum Wheel L/V	0.73	0.77	1
Max Truck Side L/V	0.40	0.42	0.6
Min vert wheel load, %	55	54	10
	Empty car		
Maximum Wheel L/V	0.88	1.0	1
Max Truck Side L/V	0.51	0.56	0.6
Min vert wheel load, %	39	36	10

## 5.5 Bi-Level Autorack Car

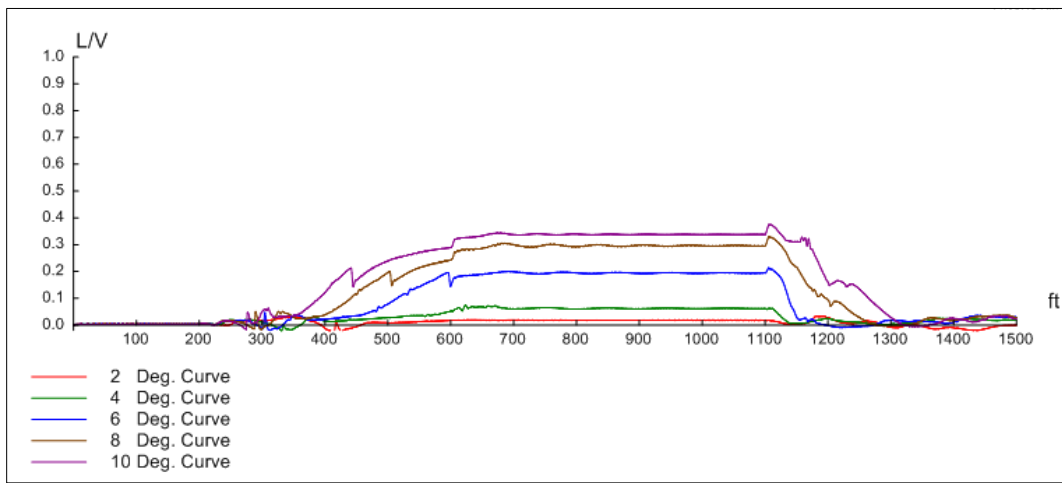
Figure 16 shows the bi-level Autorack car model, which can carry eight automobiles in two levels. As mentioned, the automobile suspension and tire stiffness were modelled along with automobile masses to account for displacements due to vertical bumps on the track. This is done to ensure the automobiles do not come off the chocks that secure the automobile wheels.

### 5.5.1 Steady State Curve (No Track Perturbations)

Figure 57 shows the wheel L/V ratios for the high rail wheel of the leading axle of a loaded Autorack car negotiating a 6-degree curve. The maximum L/V ratio at 22 mph with 1.5 inches of under balance is slightly higher than the ratios at the balance and over balance speeds. This is because vertical wheel unloading on the high rail occurs at under balance speeds and the lower vertical force results in higher L/V ratio. For all three speeds, the maximum wheel L/V ratio is a much lower limit value of 1.0 as per the requirement in Chapter 11 of AAR Standard M-1001. Figure 58 plots the high rail wheel L/V ratios at the balance speeds over a range of curvatures from 2 to 10 degrees in 2-degree increments. The results follow the expected trend of higher L/V ratios with the increase in curvatures (i.e., smaller radii curves).

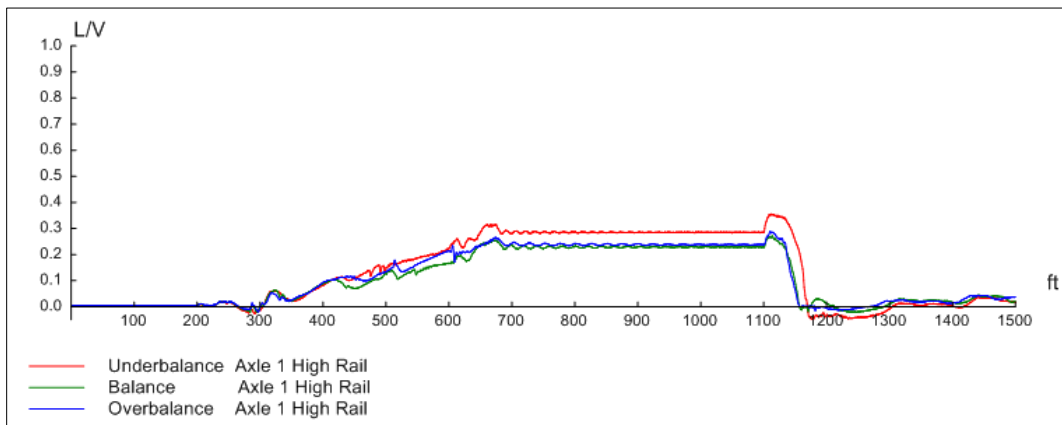


**Figure 57. Wheel L/V Ratio for a Loaded Autorack Car (Steady State Curve)**



**Figure 58. Wheel L/V Ratios Over a Range of Curves (Loaded Autorack Car)**

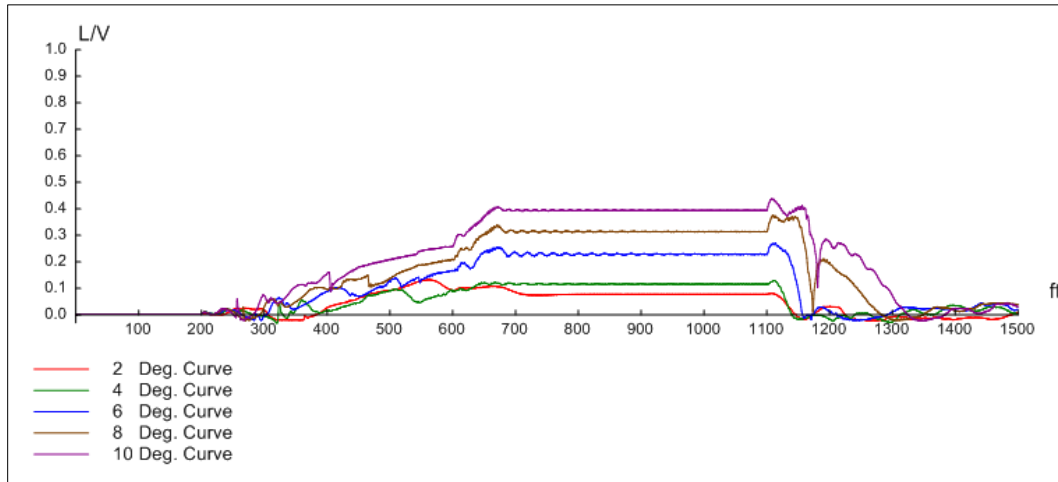
Figure 59 shows the wheel L/V ratio for an empty Autorack car negotiating a 6-degree curve.



**Figure 59. Wheel L/V Ratio for an Empty Autorack Car (Steady State Curve)**

The wheel L/V ratios for the empty car are higher than the loaded car because the vertical load is lower for the empty car. The wheel L/V ratio of 0.36 for the under balance speed is slightly higher than the other two cases because of the lower wheel vertical force on the high rail at this

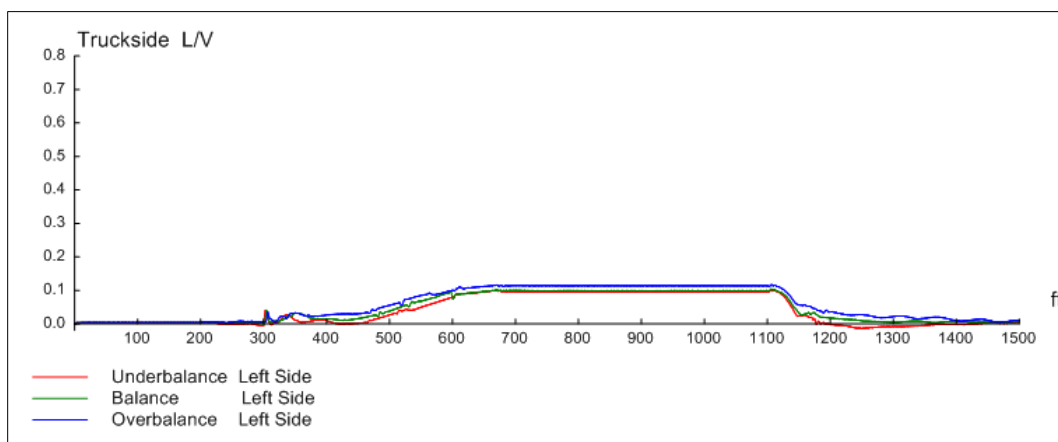
lower speed as the empty car negotiates the curve. Figure 60 shows the wheel L/V ratios for an empty Autorack car for a range of curvatures. As expected, higher wheel L/V ratios occur as the curvature increases. The maximum wheel L/V ratio for a 10-degree curve is well below the allowable limit of 1.0.



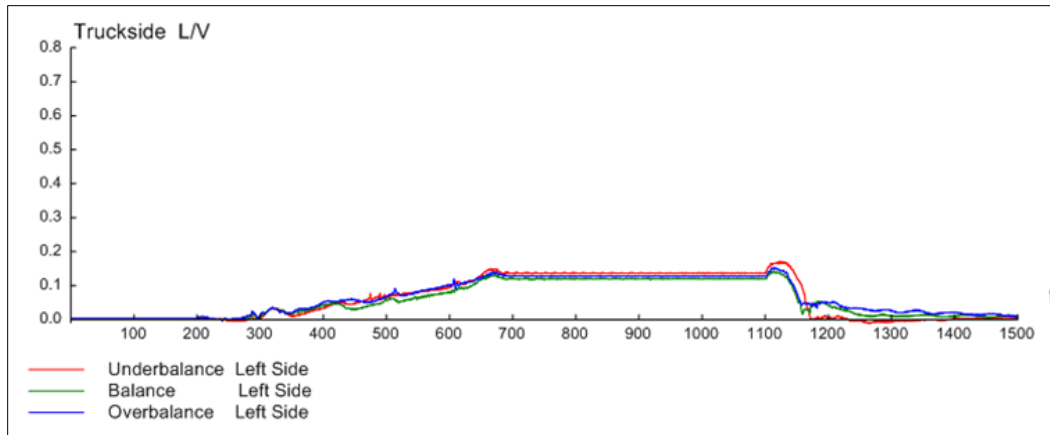
**Figure 60. Wheel L/V Ratios Over a Range of Curves (Empty Autorack Car)**

Figure 61 and Figure 62 plot the truck side L/V ratios for the loaded and empty Autorack cars. The maximum truck side L/V ratios for the loaded car shows a trend like that observed for the covered hopper car. For the empty car, the maximum truck side L/V ratio occurs at under balance speed. The maximum truck side L/V ratios are well below the allowable value of 0.6.

Table 24 summarizes the response of the loaded and empty tank car negotiating steady state curves. The predicted wheel and truck side L/V ratios are lower for the Autorack car with the Swing Motion trucks when compared to other car types with the conventional three-piece trucks (see the tank car summary in Table 21). As described in Section 2.10, special design features in the Swing Motion trucks used in the Autorack cars allow for better steering in curves, leading to lower L/V ratios when compared to other car types with conventional three-piece trucks.



**Figure 61. Truck Side L/V Ratio for a Loaded Autorack Car (Steady State Curve)**



**Figure 62. Truck Side L/V Ratio for an Empty Autorack Car (Steady State Curve)**

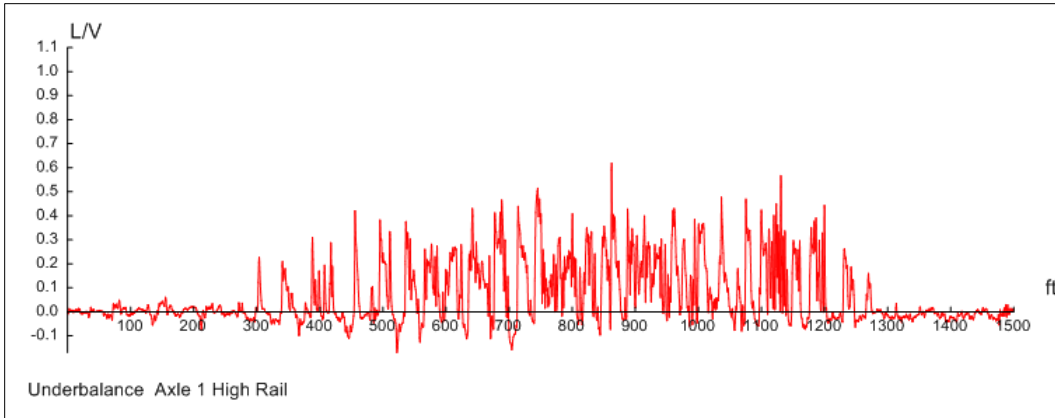
**Table 24. Predicted Autorack Car Response (Steady State Curve)**

Criterion	Curvature, degrees					AAR M-1001
	2	4	6	8	10	
	Loaded Car					
Maximum Wheel L/V	0.11	0.11	0.26	0.40	0.43	1
Max Truck Side L/V	0.06	0.06	0.14	0.20	0.23	0.6
Min vert wheel load, %	82	79	78	77	78	10
	Empty car					
Maximum Wheel L/V	0.18	0.22	0.36	0.42	0.47	1
Max Truck Side L/V	0.10	0.13	0.18	0.22	0.27	0.6
Min vert wheel load, %	81	70	67	68	70	10

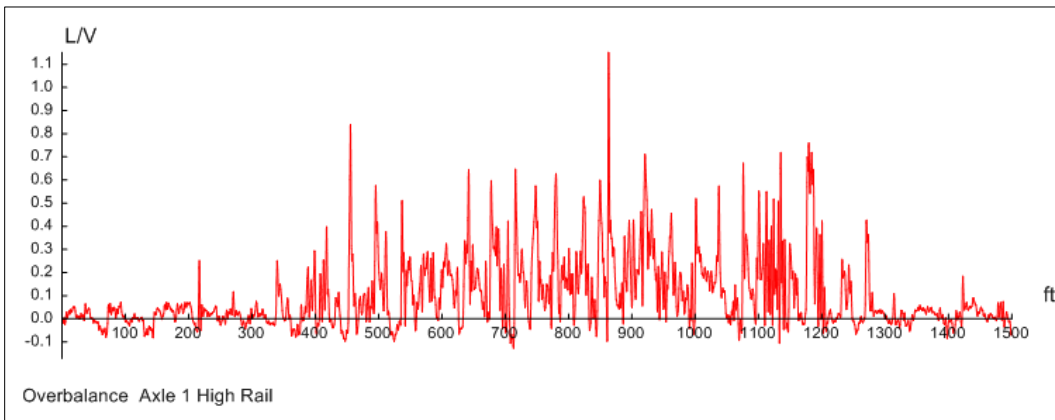
### 5.5.2 Response for Track with Perturbations

Section 3.2 discusses FRA Class 3 track irregularities or perturbations added to 4- and 6-degree design curves. The responses of the loaded and empty Autorack cars as they negotiated a 6-degree curve with track perturbations are discussed in this section. Figure 63 shows the wheel L/V ratio for a loaded Autorack car negotiating a 6-degree curve with track perturbations. The maximum value of 0.62 is well below the AAR limit of 1.0.

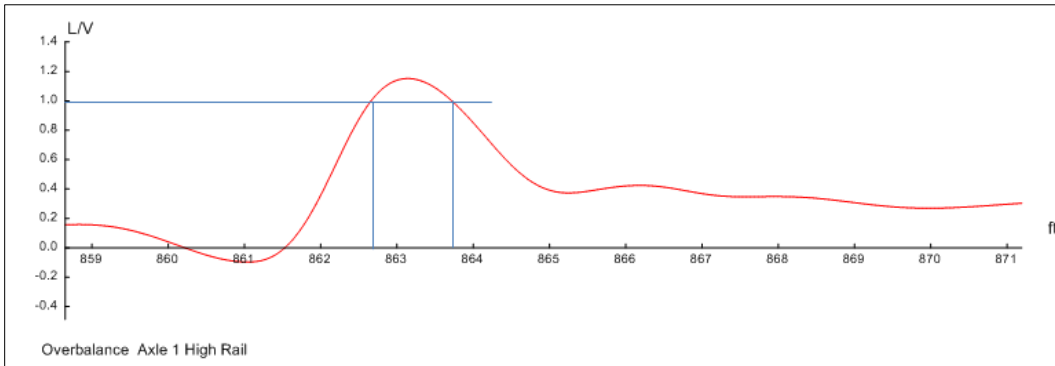
Figure 64 shows the peak wheel L/V ratio is 1.15 for an empty car negotiating a 6-degree curve with FRA Class 3 track perturbations. The peak value is higher than the AAR allowable value of 1.0. Figure 65 shows a zoomed-in view of the peak wheel L/V ratio where the maximum value above the allowable value of 1.0 is sustained only for a distance of about a foot. Figure 66 provides a zoomed-in view of the peak wheel L/V ratio in time scale where the maximum value is above the allowable limit only for about 20 ms. As per the AAR M-1001 Chapter 11 Standard, the peak wheel L/V ratio must not exceed 1.0 for a period greater than 50 ms nor for a distance greater than 3 feet. The maximum wheel L/V ratio for this scenario is 0.84, the second highest peak in Figure 64. Table 25 summarizes the results for 4- and 6-degree curves. The maximum L/V ratios predicted for the Autorack cars going over curves with perturbations are also less than the predicted values for other car types (see Table 23).



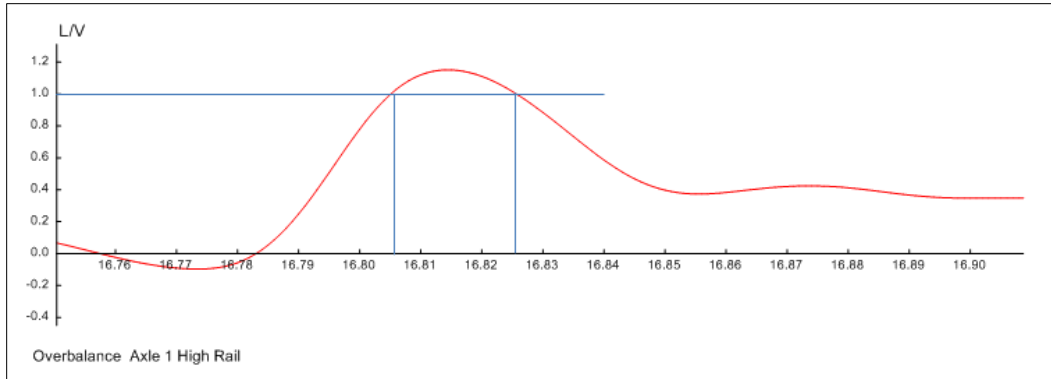
**Figure 63. Wheel L/V Ratio, Loaded Autorack Car (6-Degree Curve with Perturbations)**



**Figure 64. Wheel L/V Ratio, Empty Autorack Car (6-Degree Curve with Perturbations)**



**Figure 65. Wheel L/V Ratio, Zoomed-in, Distance Scale (Empty Car on a 6-Degree Curve with Perturbations)**



**Figure 66. Wheel L/V Ratio, Zoomed-in Time Scale (Empty Car on a 6-Degree Curve with Perturbations)**

**Table 25. Predicted Autorack Car Response (Curve with Perturbations)**

	Curvature, degrees		
	4	6	
Criterion	Loaded Car		AAR M-1001 Limit
Max Wheel L/V	0.52	0.62	1
Max Truck Side L/V	0.31	0.45	0.6
Min Vert Wheel Load, %	38	37	10
	Empty Car		
Max Wheel L/V	0.89	0.84*	1
Max Truck Side L/V	0.43	0.55	0.6
Min Vert Wheel Load, %	26	28	10

\* Second highest peak value reported. Refer to [Section 5.4.2](#) for details.



## 6. Summary and Conclusions

---

The research team created a library of railway freight car models for 12 different car types using VAMPIRE, a vehicle dynamics simulation software. The team also created a library of track input files for a range of curvatures. To evaluate the effect of measured track geometry on the dynamic response of freight cars, the team developed track input files with perturbations corresponding to FRA Class 3 and Class 4 tracks. TEDS simulations can be added to the VAMPIRE models developed for this project by individual vehicle dynamics simulations of key derailed cars.

This report discussed the results of vehicle dynamics analyses for this sub-set of car types to illustrate the effectiveness of the modeling techniques in predicting key parameters of vehicle/track interaction. The results in terms of wheel L/V ratios and other parameters for each car type indicate that the predicted values were reasonable and were in the expected range for the curvatures and speeds considered for the simulations.

The team found that the vehicle dynamics models made from the library of car, wheel, and rail profile combinations can be used in future derailment investigations when VTI is considered a possible cause. Using the models, researchers can input measured track defect data from a derailment incident investigation to simulate and study that specific derailment. This can be a valuable tool in derailment investigation.

## References

---

Association of American Railroads (2020). Service Worthiness Tests and Analysis for New Freight Cars. AAR M-1001 Specification, *Chapter 11 in AAR Manual of Standards and Recommended Practices*, Section C-Part II.

Association of American Railroads (2020). Railroad Facts. *Policy and Economics Department*, Washington, DC: Association of American Railroads.

Andersen, P. (2011). Rolling Stock: Locomotives and Rail Cars – Industry & Trade Summary. *Office of Industries Publication ITS-08*, US International Trade Commission.

Kratville, W. W. (Editor) (1997). The Car and Locomotive Cyclopedia of American Practices. *Simmons-Boardman Books, Inc*, Omaha, NE.

Rakoczy, A. M. et al. (2019). Articulated Double-Stack Car Effects on Bridges. *AREMA Conference*.

Schorr, R. (2015). Basics of Vehicle Truck and Suspension Systems and Fundamentals of Vehicle Steering and Stability. *WRI Principles Course*.

## **Abbreviations and Acronyms**

---

<b>ACRONYM</b>	<b>DEFINITION</b>
AREMA	American Railway Engineering and Maintenance-of-way Association
ASF	American Steel Foundry
AAR	Association of American Railroads
FRA	Federal Railroad Administration
GRL	Gross Rail Load
L/V	Lateral Force to Vertical Force Ratio
MSRP	Manual of Standards and Recommended Practices
MCO	Mid-Chord Offset
SOW	Scope of Work
TOFC	Trailer On Flat Car
TEDS	Train Energy and Dynamics Simulator
TTCI	Transportation Technology Center, Inc.
VTI	Vehicle/Track Interaction
WRI	Wheel Rail Interaction